

SOLUTIONS MODULAIRES ET COMPTOIRS

MODULAR SOLUTIONS AND COUNTERS



FR

- Grande variété de tailles et configurations.
- Conception robuste et résistante.
- Forte résistance au chargement.
- Plusieurs configurations.
- Ouverture des portes à 180 °.
- Couleur standard bleu martelé possibilité teintes en option. SÉRIE 170 (RAL 5017-RAL 2009).

EN

- Wide range of sizes and configurations.
- Strong and resistant design.
- High weight-bearing resistance.
- Several configurations.
- 180 ° opening doors.
- Standard colour hammered blue possibility optional colours. SERIE 170 (RAL 5017-RAL 2009).

SOLUCIONES MODULARES Y MOSTRADORES



ES

- Gran variedad de medidas y configuraciones.
- Diseño robusto y resistente.
- Alta resistencia de carga.
- Varias configuraciones.
- Apertura de puertas de 180 °.
- Color estándar azul martelé posibilidad colores en opción. SERIE 170 (RAL 5017-RAL 2009).





SERIE 115 E ref. 115 E 1 / 115 E 2 / 115 E 3

Armarios con cajones y estanterías.
Armoires avec tiroirs et étagères.
Cabinets with drawers and shelves.

Sistema antivuelco.
Système anti-renversement.
Anti-roll system.

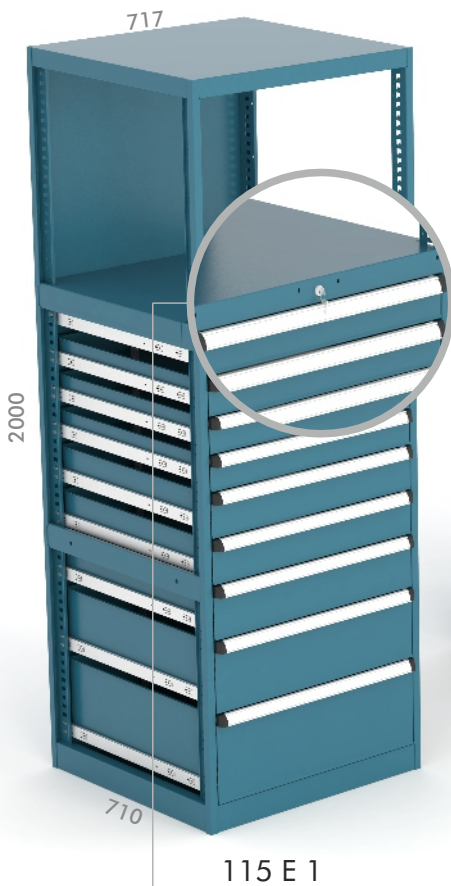

115 E 1

Cierre centralizado.
Verrouillage centralisé.
Central locking.

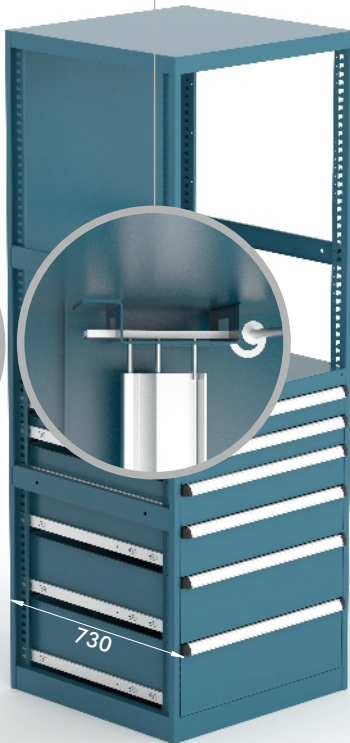

115 E 2



115 E 3

Estructura modular.
Structure modulaire.
Modular frame.

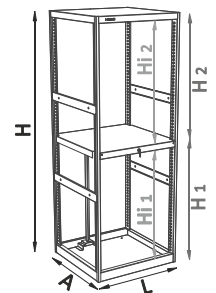

	LxAxH (mm)	H1 (mm)	H2 (mm)	Hi 1 (mm)	Hi 2 (mm)
115 E 1	717x710x2000	1435	600	1300	550
115 E 2	717x710x2000	1035	1000	900	950
115 E 3	717x710x2000	735	1300	600	1250

e 1 mm

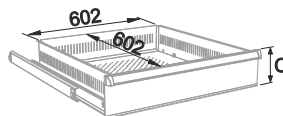

SERIE 115	C	●	GT 100 KG	
			Model	Weight
	C=50	●	115 T100 C50	10,5Kg
	C=75	●	115 T100 C75	11Kg
	C=100	●	115 T100 C100	12,5Kg
	C=125	●	115 T100 C125	13Kg
	C=150	●	115 T100 C150	13,5Kg
	C=200	●	115 T100 C200	14,5Kg
	C=250	●	115 T100 C250	15,5Kg
	C=300			

e 1.5 mm





Para más información de cajones, ver PAG. 45.
Pour plus d'information de tiroirs, voir PAGE. 45.
For further information of drawers, see PAGE. 45.



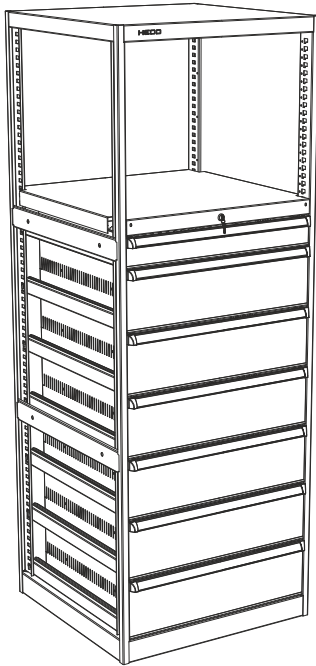

Los cajones no incluyen divisiones.
Le tiroirs non inclus les séparations.
Divisions non included at drawers.

SERIE 115 E 1 STANDARD



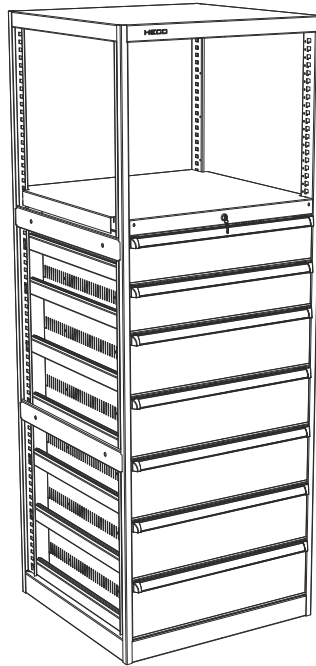

		cajones/tiroirs/drawers	
115 E 1 4 11	174,5 Kg	 	1x 115 C100 6x 115 C200



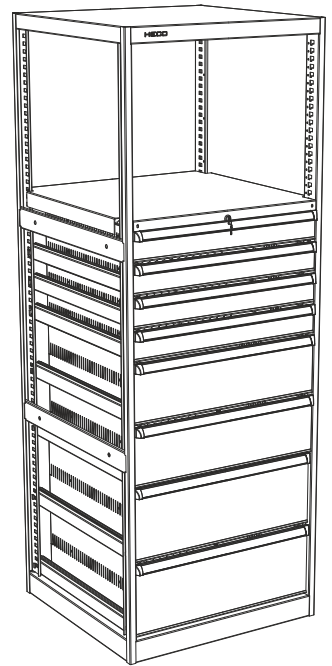

		cajones/tiroirs/drawers	
115 E 1 4 12	172,5 Kg	 	2x 115 C150 5x 115 C200



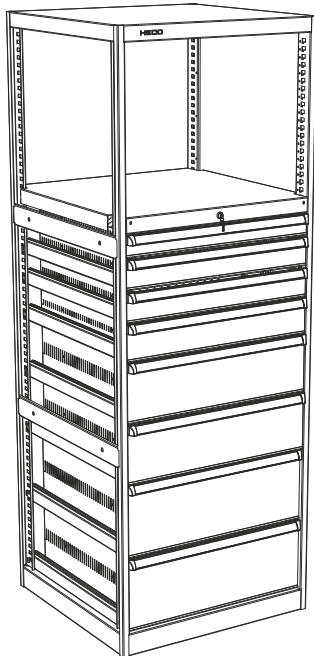

		cajones/tiroirs/drawers	
115 E 1 4 13	185 Kg	 	4x 115 C100 2x 115 C200 2x 115 C250



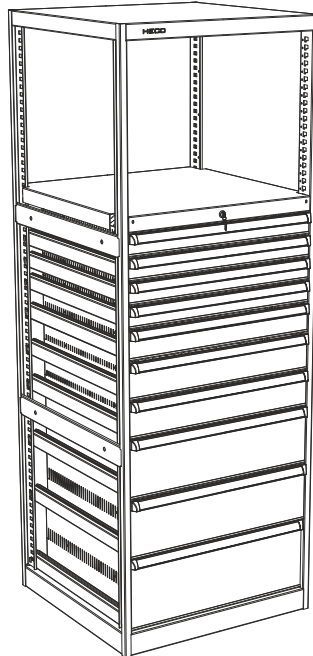

		cajones/tiroirs/drawers	
115 E 1 4 14	185 Kg	 	1x 115 C75 2x 115 C100 1x 115 C125 2x 115 C200 2x 115 C250

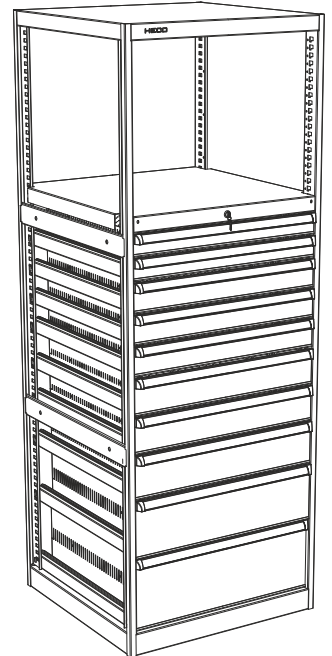

		cajones/tiroirs/drawers	
115 E 1 4 15	202 Kg	 	4x 115 C75 1x 115 C100 2x 115 C125 2x 115 C200 1x 115 C250



		cajones/tiroirs/drawers	
115 E 1 4 16	191 Kg	 	2x 115 C75 3x 115 C100 2x 115 C125 1x 115 C150 1x 115 C200 1x 115 C250



SERIE 115 E 1 STANDARD

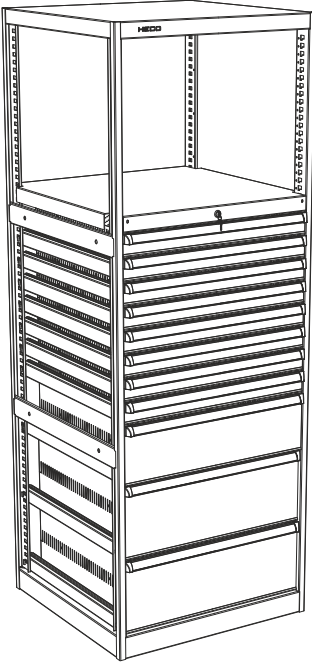

115 E 1 4 17 208,5 Kg



cajones/tiroirs/drawers

8x 115 C75
1x 115 C200
2x 115 C250

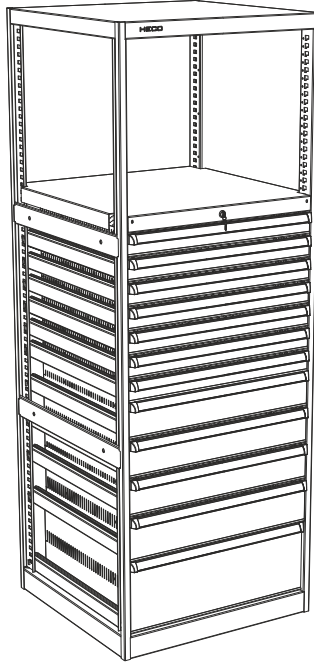

115 E 1 4 18 220 Kg



cajones/tiroirs/drawers

7x 115 C75
3x 115 C125
1x 115 C150
1x 115 C250

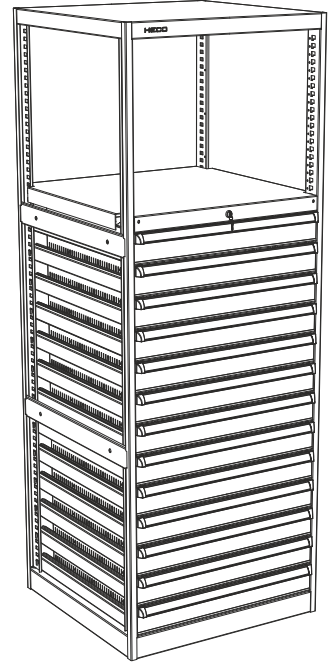

115 E 1 4 19 237 Kg



cajones/tiroirs/drawers

13x 115 C100

SERIE 115 E 2 STANDARD

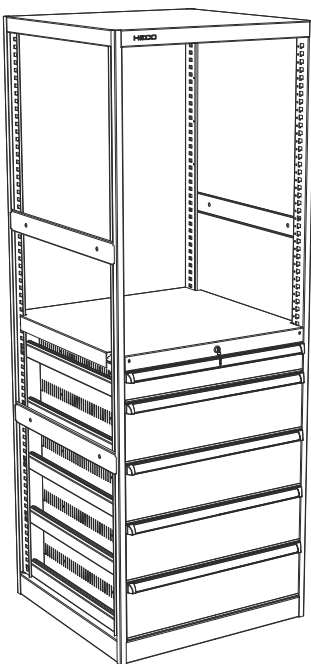

115 E 2 2 11 134 Kg



cajones/tiroirs/drawers

1x 115 C100
4x 115 C200

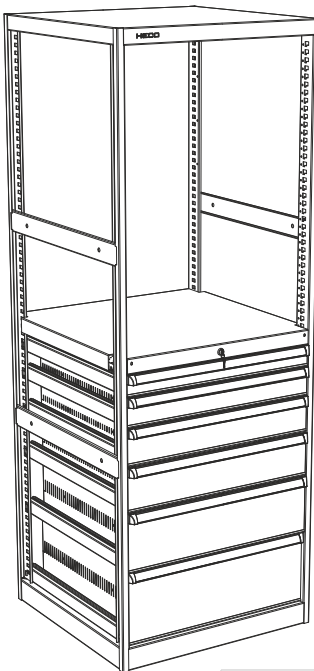

115 E 2 2 12 155 Kg



cajones/tiroirs/drawers

1x 115 C75
1x 115 C100
1x 115 C125
1x 115 C150
1x 115 C200
1x 115 C250

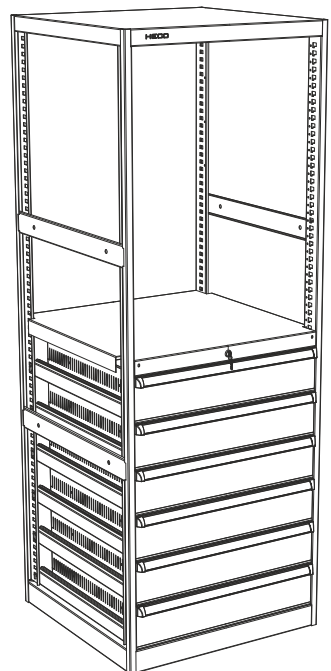

115 E 2 2 13 156 Kg





cajones/tiroirs/drawers

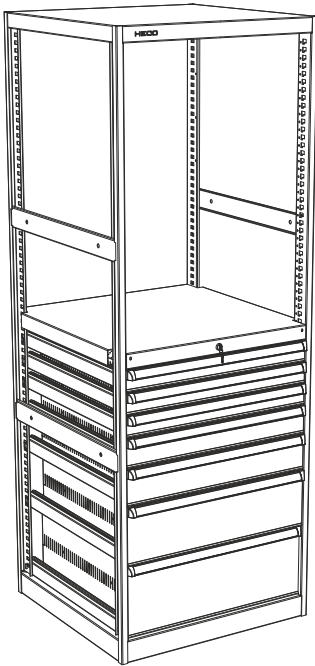

6x 115 C150

SERIE 115 E 2 STANDARD



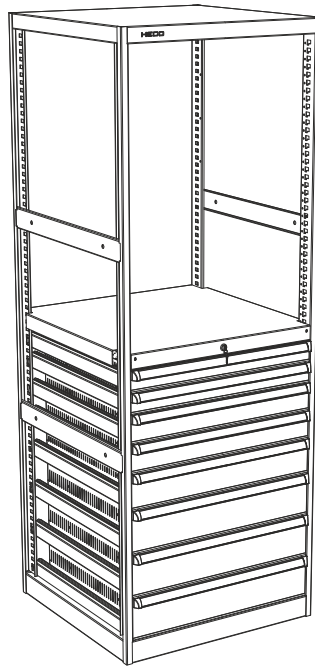

115 E 2 2 14	163,5 Kg	 	cajones/tiroirs/drawers 3x 115 C75 1x 115 C100 1x 115 C125 1x 115 C200 1x 115 C250
--------------	----------	---	---



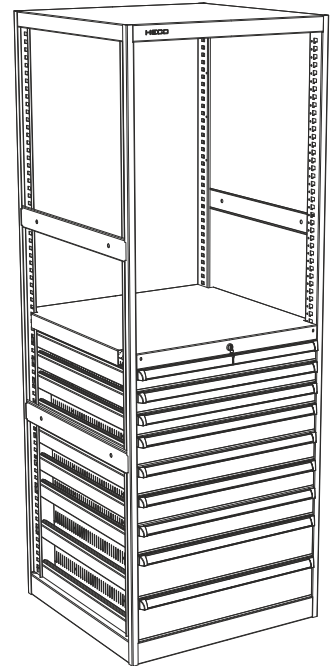

115 E 2 2 15	175 Kg	 	cajones/tiroirs/drawers 2x 115 C75 2x 115 C100 2x 115 C125 2x 115 C150
--------------	--------	---	--



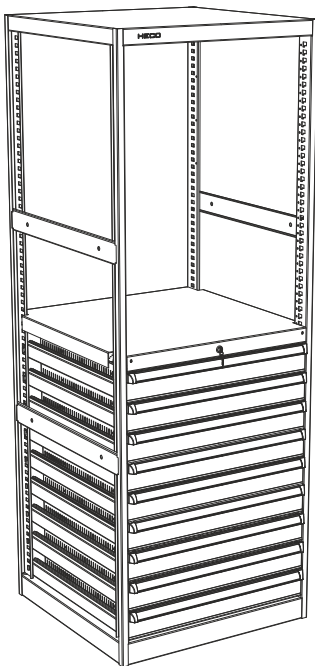

115 E 2 2 16	184,5Kg	 	cajones/tiroirs/drawers 3x 115 C75 4x 115 C100 1x 115 C125 1x 115 C150
--------------	---------	---	--

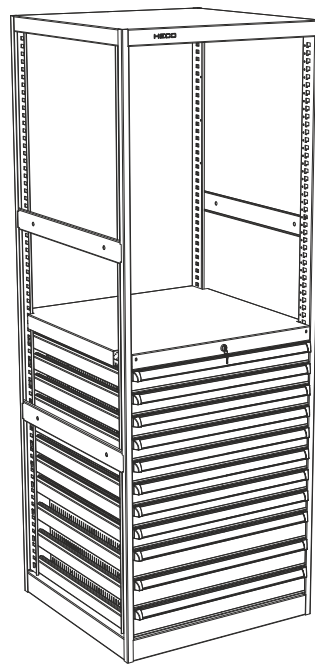

115 E 2 2 17	187,5Kg	 	cajones/tiroirs/drawers 9x 115 C100
--------------	---------	---	--



115 E 2 2 18	200,5 Kg	 	cajones/tiroirs/drawers 8x 115 C75 3x 115 C100
--------------	----------	---	--

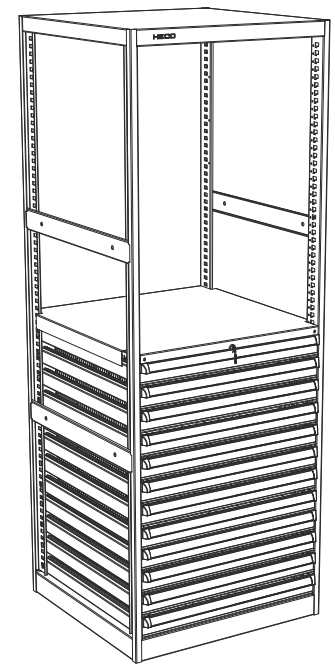

115 E 2 2 19	207 Kg	 	cajones/tiroirs/drawers 12x 115 C75
--------------	--------	---	--



SERIE 115 E 3 STANDARD

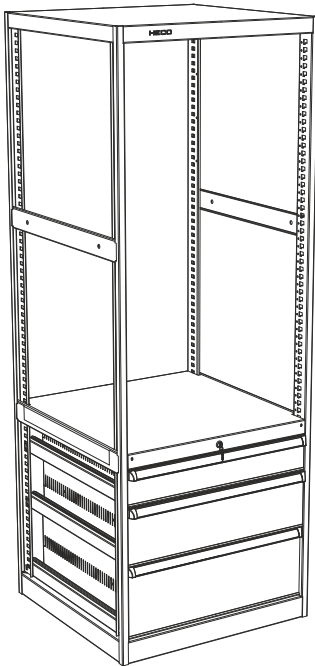

115 E 3 1 11	118 Kg			cajones/tiroirs/drawers 1x 115 C150 1x 115 C200 1x 115 C250
--------------	--------	--	--	--

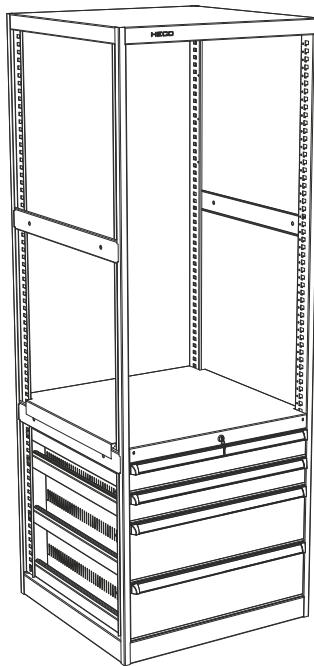

115 E 3 1 12	129 Kg			cajones/tiroirs/drawers 2x 115 C100 2x 115 C200
--------------	--------	--	--	---

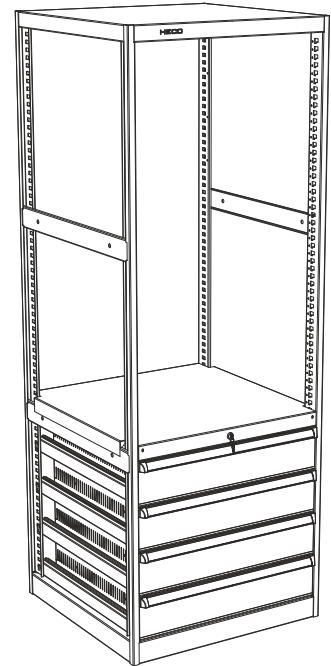

115 E 3 1 13	129 Kg			cajones/tiroirs/drawers 4x 115 C150
--------------	--------	--	--	--

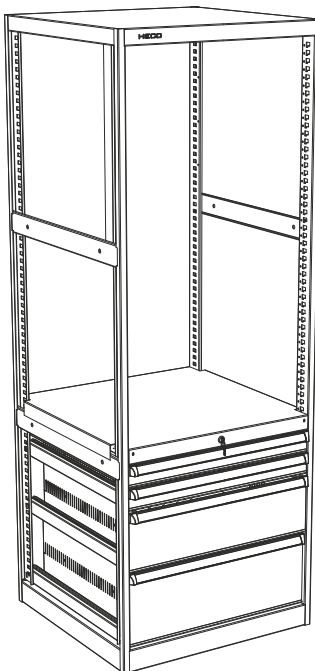

115 E 3 1 14	127 Kg			cajones/tiroirs/drawers 2x 115 C75 1x 115 C200 1x 115 C250
--------------	--------	--	--	---

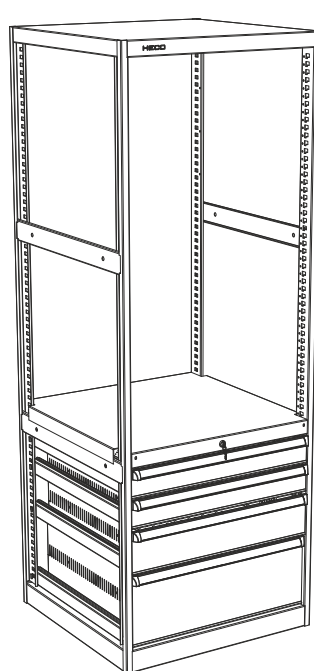

115 E 3 1 15	128 Kg			cajones/tiroirs/drawers 2x 115 C100 1x 115 C150 1x 115 C250
--------------	--------	--	--	--

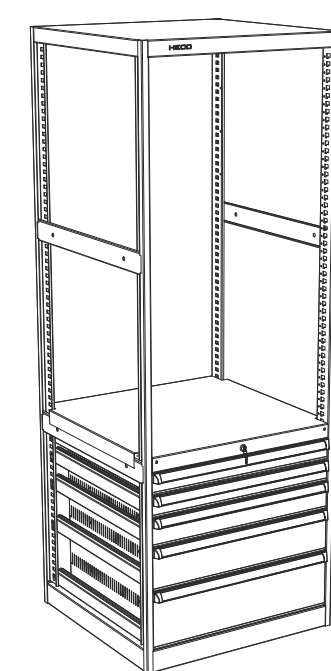

115 E 3 1 16	137,5 Kg			cajones/tiroirs/drawers 2x 115 C75 1x 115 C100 1x 115 C150 1x 115 C200
--------------	----------	--	--	--

SERIE 115 E 3 STANDARD

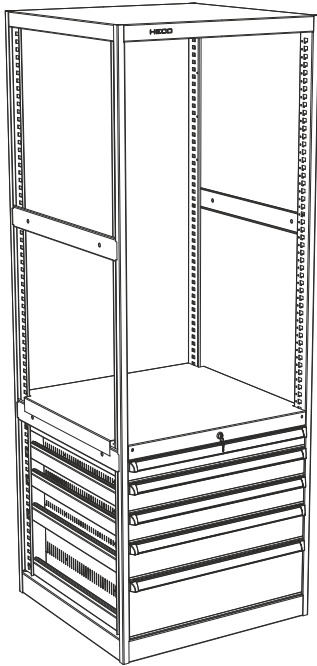

cajones/tiroirs/drawers

115 E 3 1 17	138,5 Kg	 	1x 115 C75 2x 115 C100 1x 115 C125 1x 115 C200
--------------	----------	---	---

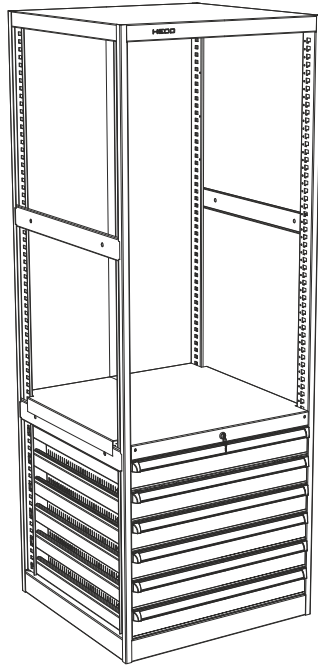

cajones/tiroirs/drawers

115 E 3 1 18	150 Kg	 	6x 115 C100
--------------	--------	---	-------------

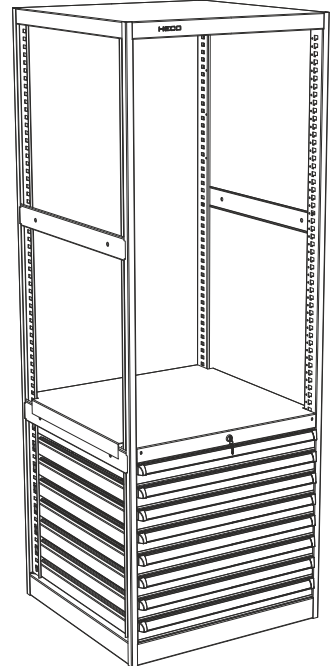

cajones/tiroirs/drawers

115 E 3 1 19	141 Kg	 	8x 115 C75
--------------	--------	---	------------

SERIE 115 E COMPONENTES / COMPOSANTS / COMPONENTS

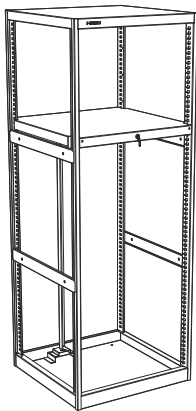

LxAxH (mm)

115 E 1 MC	75 Kg	717x710x2000
------------	-------	--------------

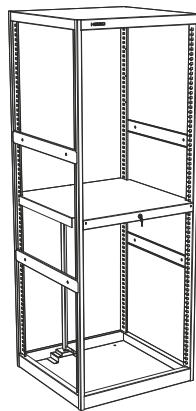

LxAxH (mm)

115 E 2 MC	75 Kg	717x710x2000
------------	-------	--------------

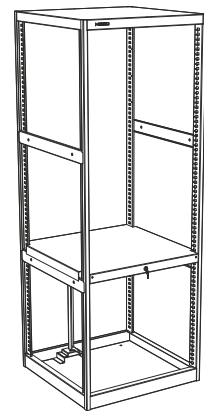

LxAxH (mm)

115 E 3 MC	75 Kg	717x710x2000
------------	-------	--------------

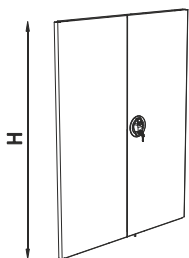

		H (mm)
115 E 1 P	5,5 Kg	535
115 E 2 P	7,3 Kg	935
115 E 3 P	8,6 Kg	1235
115 E P	9,9 Kg	1915

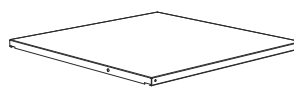

descripción/description/description

115 EG	8 Kg	estantería graduable étagère réglable adjustable shelf
--------	------	--

Soportes incluidos / Supports inclus / Included supports

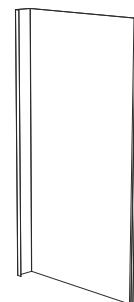

LxH (mm)

115 E L	13 Kg	730x2000
---------	-------	----------

lateral / latéral / lateral



SERIE 119 E ref. 119 E 1 / 119 E 2 / 119 E 3

Armarios con cajones y estanterías.
Armoires avec tiroirs et étagères.
Cabinets with drawers and shelves.

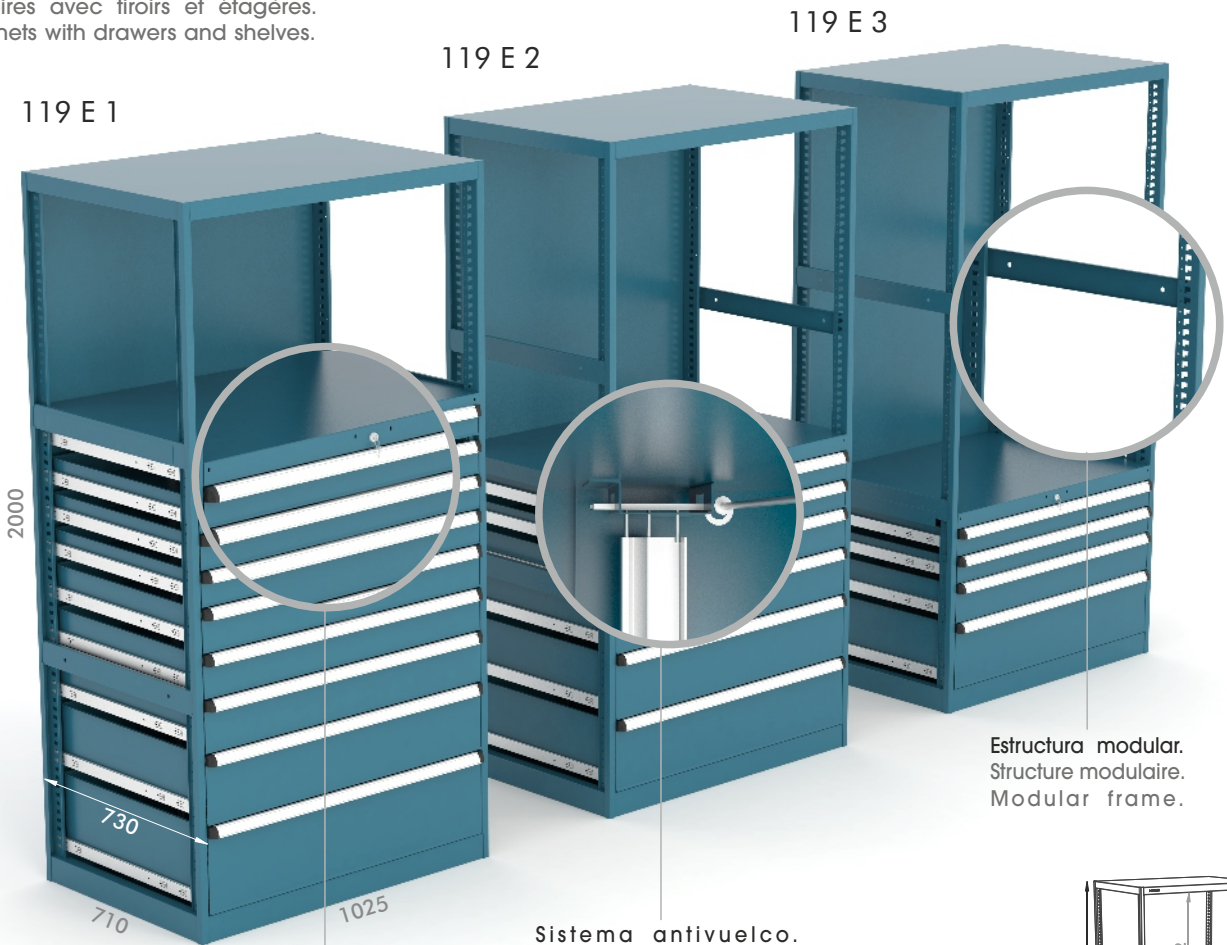

Estructura modular.
Structure modulaire.
Modular frame.

Sistema antivuelco.
Système anti-renversement.
Anti-roll system.

Cierre centralizado.
Verrouillage centralisé.
Central locking.

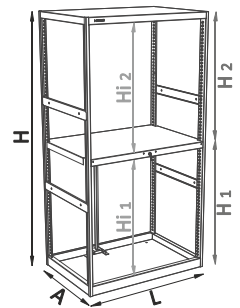

	LxAxH (mm)	H1 (mm)	H2 (mm)	Hi 1 (mm)	Hi 2 (mm)
119 E 1	1025x710x2000	1435	600	1300	550
119 E 2	1025x710x2000	1035	1000	900	950
119 E 3	1025x710x2000	735	1300	600	1250

e 1 mm

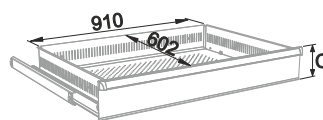

		GT	100	
SERIE 119	C=50	●	119 T50 C75	15,5Kg
	C=75	●	119 T50 C100	16,5Kg
	C=100	●	119 T50 C125	17,5Kg
	C=125	●	119 T50 C150	18,5Kg
	C=150	●	119 T50 C200	19Kg
	C=200	●	119 T50 C250	20Kg
	C=250	●	119 T50 C250	22,5Kg
C=300				
		e	1.5 mm	





Para más información de cajones, ver PAG. 45.
Pour plus d'information de tiroirs, voir PAGE. 45.
For further information of drawers, see PAGE. 45.



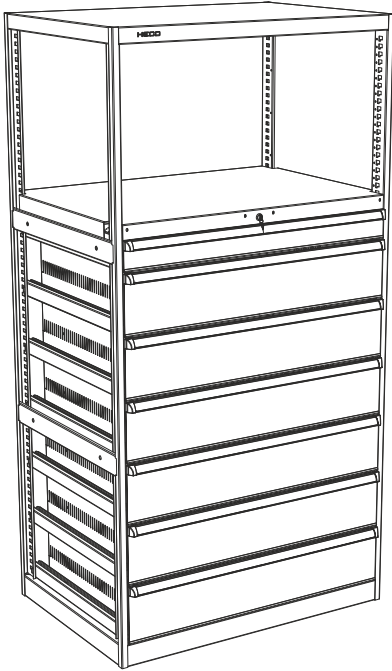

Los cajones no incluyen divisiones.
Le tiroirs non inclus les séparations.
Divisions non included at drawers.

SERIE 119 E 1 STANDARD



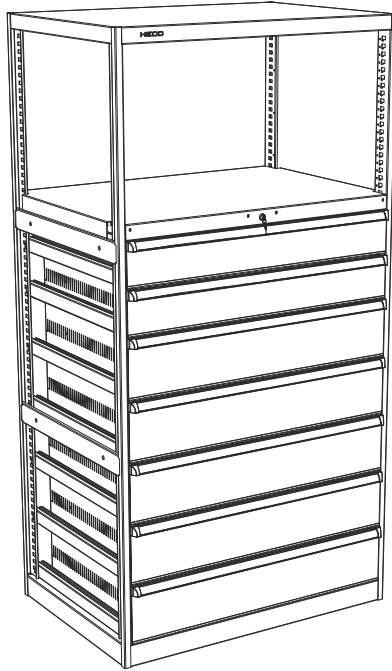

119 E 1 4 11	249,5 Kg	 	cajones/tiroirs/drawers 1x 119 C100 6x 119 C200
--------------	----------	---	---



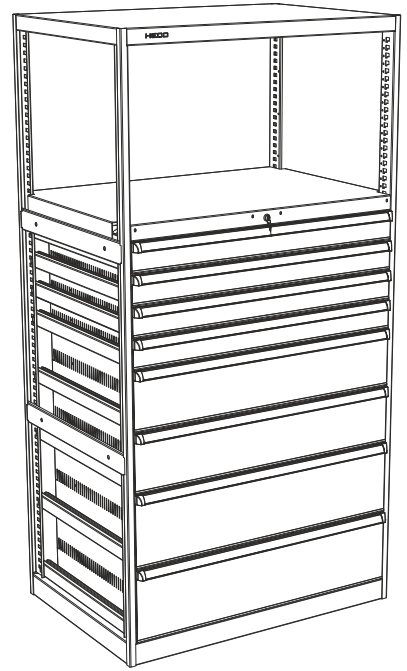

119 E 1 4 12	295 Kg	 	cajones/tiroirs/drawers 2x 119 C150 5x 119 C200
--------------	--------	---	---



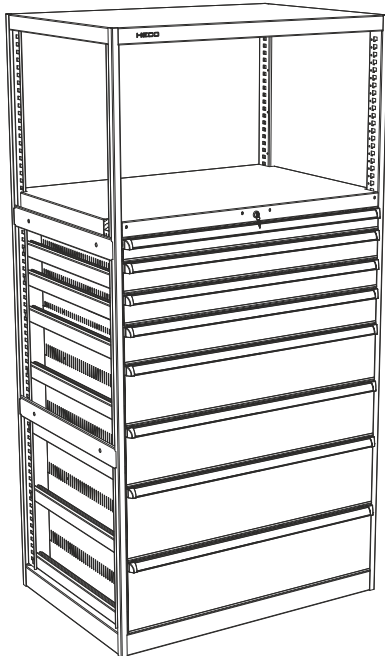

119 E 1 4 13	262 Kg	 	cajones/tiroirs/drawers 4x 119 C100 2x 119 C200 2x 119 C250
--------------	--------	---	--



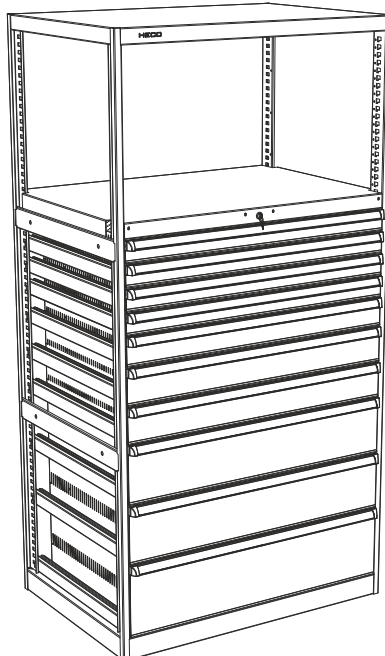

119 E 1 4 14	267 Kg	 	cajones/tiroirs/drawers 1x 119 C75 2x 119 C100 1x 119 C125 2x 119 C200 2x 119 C250
--------------	--------	---	---

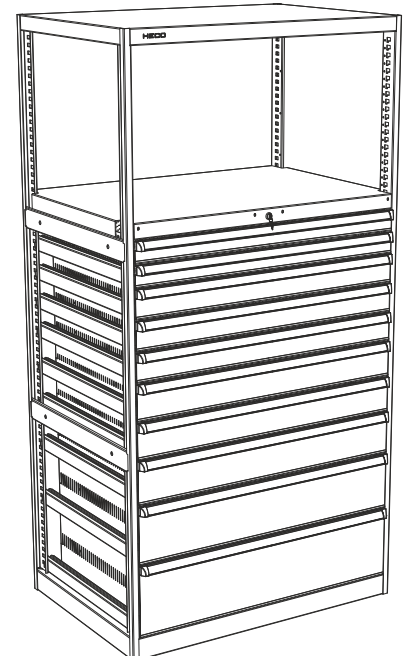

119 E 1 4 15	295 Kg	 	cajones/tiroirs/drawers 4x 119 C75 1x 119 C100 2x 119 C125 2x 119 C200 1x 119 C250
--------------	--------	---	---



119 E 1 4 16	278,5 Kg	 	cajones/tiroirs/drawers 2x 119 C75 3x 119 C100 2x 119 C125 1x 119 C150 1x 119 C200 1x 119 C250
--------------	----------	---	--



SERIE 119 E 1 STANDARD

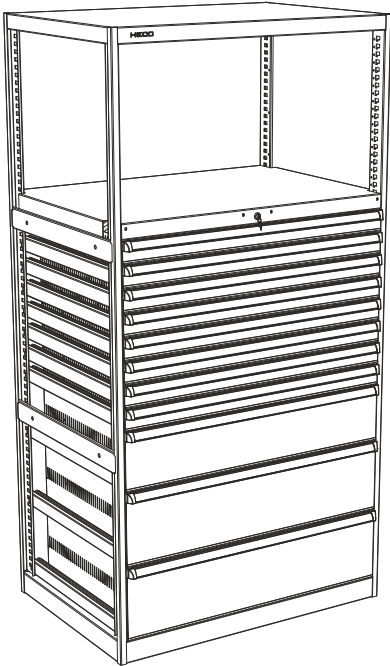

119 E 1 4 17	309 Kg			cajones/tiroirs/drawers 8x 119 C75 1x 119 C200 2x 119 C250
--------------	--------	--	--	---

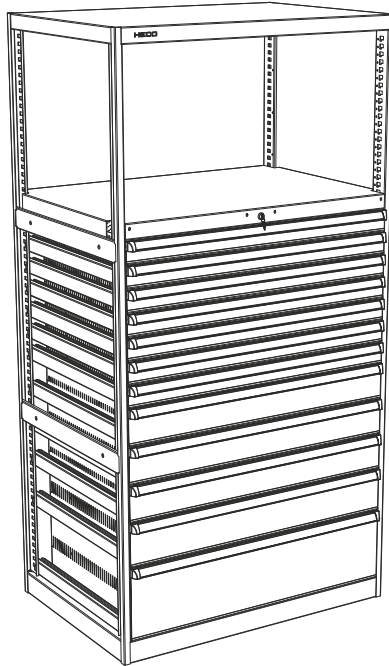

119 E 1 4 18	324,5 Kg			cajones/tiroirs/drawers 7x 119 C75 3x 119 C125 1x 119 C150 1x 119 C250
--------------	----------	--	--	--

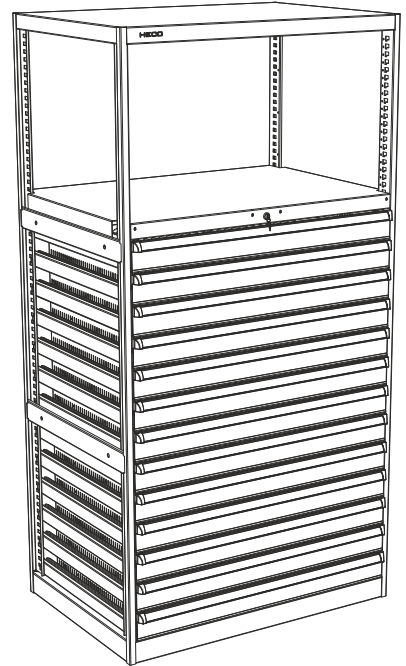

119 E 1 4 19	339,5 Kg			cajones/tiroirs/drawers 13x 119 C100
--------------	----------	--	--	---

SERIE 119 E 2 STANDARD

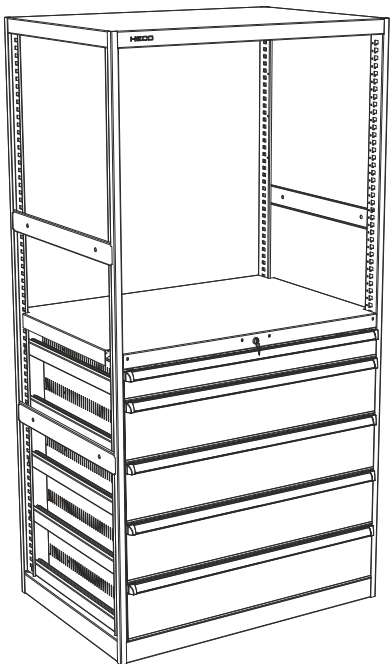

119 E 2 2 11	215 Kg			cajones/tiroirs/drawers 1x 119 C100 4x 119 C200
--------------	--------	--	--	---

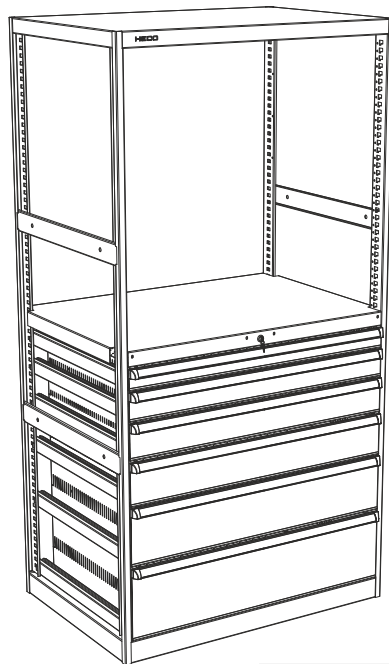

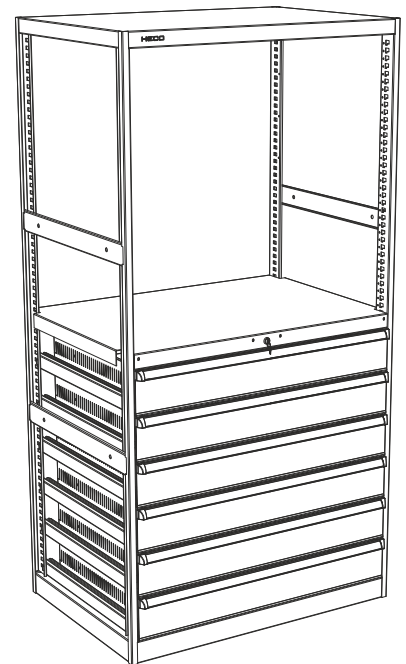

119 E 2 2 12	226 Kg			cajones/tiroirs/drawers 1x 119 C75 1x 119 C100 1x 119 C125 1x 119 C150 1x 119 C200 1x 119 C250
--------------	--------	--	--	--



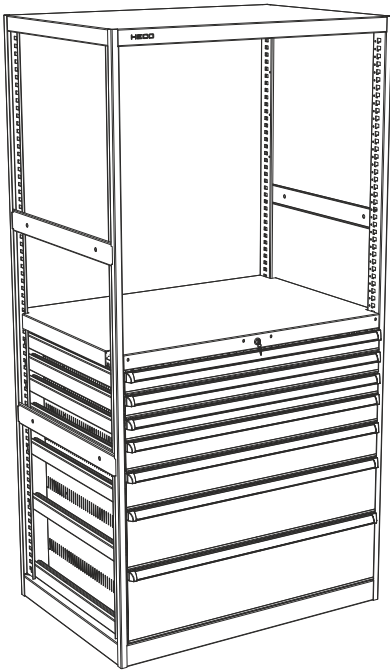

119 E 2 2 13	226 Kg			cajones/tiroirs/drawers 6x 119 C150
--------------	--------	--	--	--

SERIE 119 E 2 STANDARD



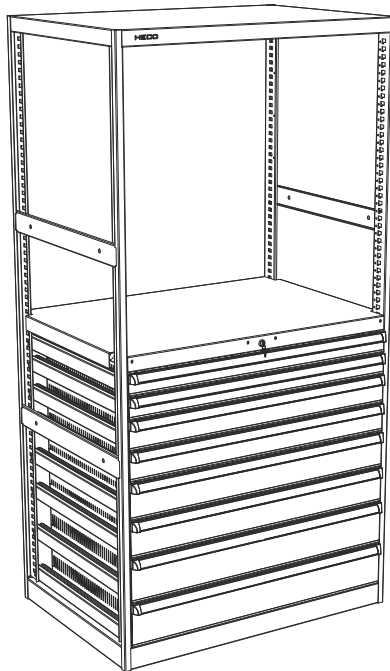

119 E 2 14	240 Kg	 	cajones/tiroirs/drawers 3x 119 C75 1x 119 C100 1x 119 C125 1x 119 C200 1x 119 C250
------------	--------	---	---



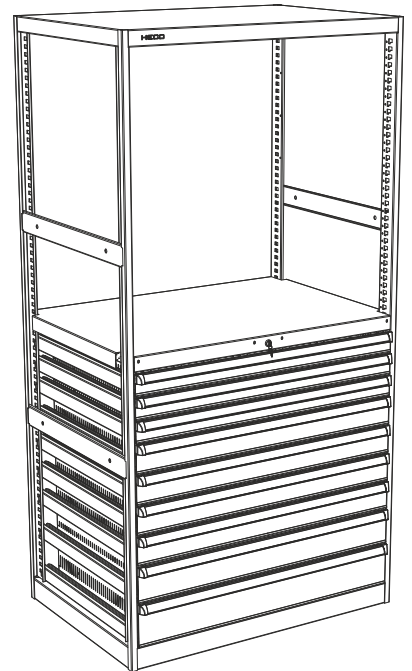

119 E 2 15	255 Kg	 	cajones/tiroirs/drawers 2x 119 C75 2x 119 C100 2x 119 C125 2x 119 C150
------------	--------	---	--



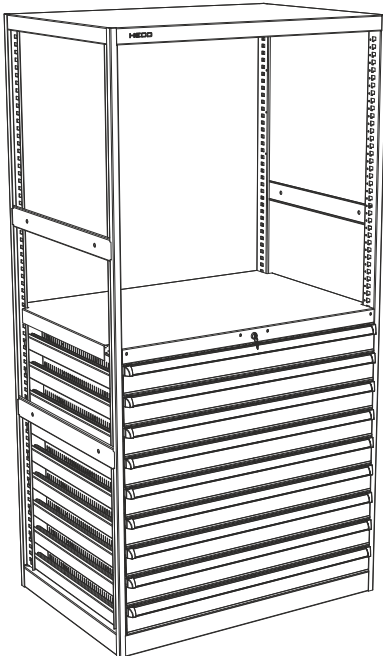

110 E 2 16	269Kg	 	cajones/tiroirs/drawers 3x 119 C75 4x 119 C100 1x 119 C125 1x 119 C150
------------	-------	---	--



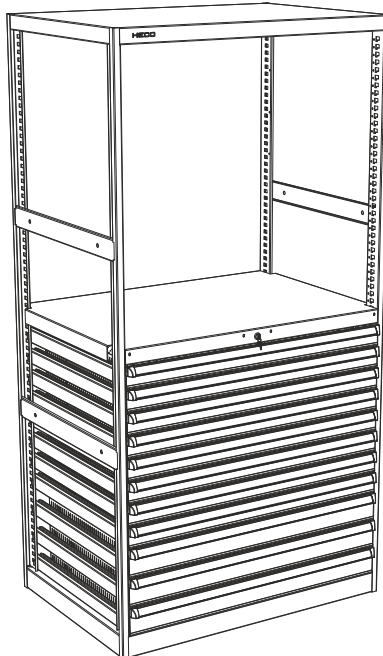

119 E 2 17	269,5Kg	 	cajones/tiroirs/drawers 9x 119 C100
------------	---------	---	--

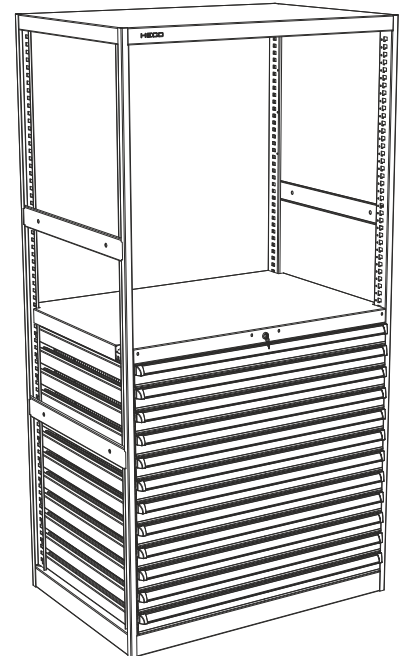

119 E 2 18	296,5 Kg	 	cajones/tiroirs/drawers 8x 119 C75 3x 119 C100
------------	----------	---	--



119 E 2 19	310 Kg	 	cajones/tiroirs/drawers 12x 119 C75
------------	--------	---	--



SERIE 119 E 3 STANDARD

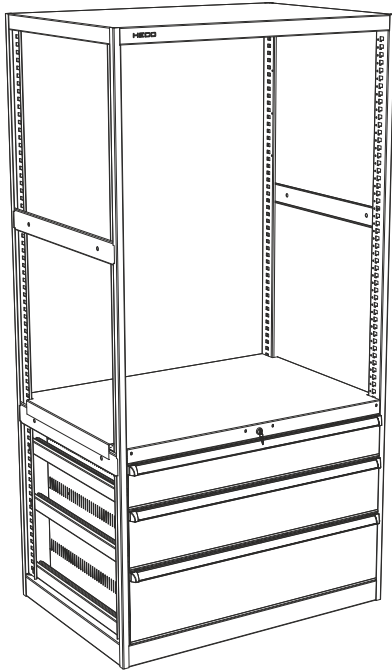

119 E 3 1 11	173,5 Kg			cajones/tiroirs/drawers
				1x 119 C150 1x 119 C200 1x 119 C250

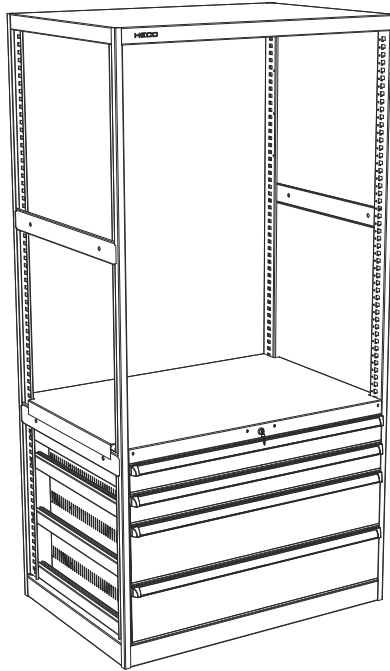

119 E 3 1 12	187 Kg			cajones/tiroirs/drawers
				2x 119 C100 2x 119 C200

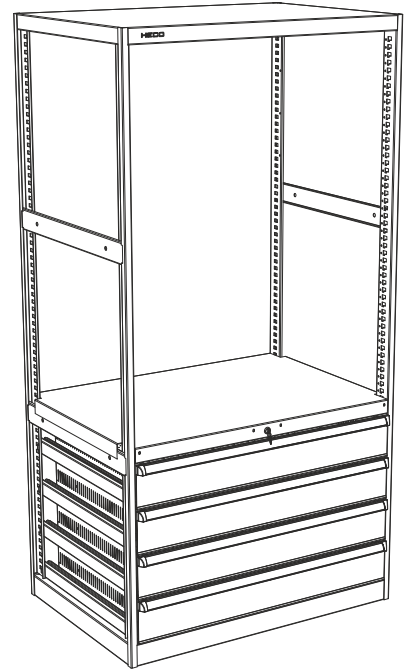

119 E 3 1 13	188 Kg			cajones/tiroirs/drawers
				4x 119 C150

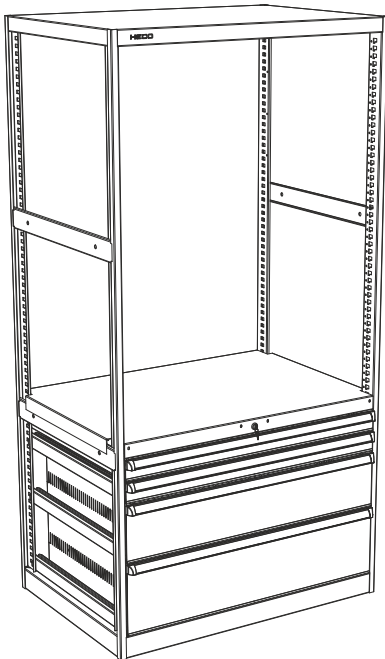

119 E 3 1 14	187,5 Kg			cajones/tiroirs/drawers
				2x 119 C75 1x 119 C200 1x 119 C250

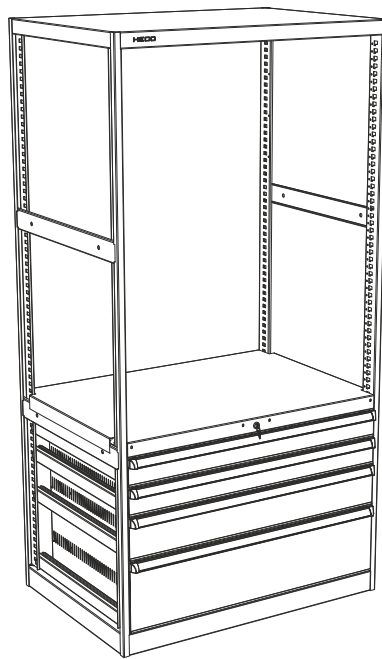

119 E 3 1 15	188,5 Kg			cajones/tiroirs/drawers
				2x 119 C100 1x 119 C150 1x 119 C250

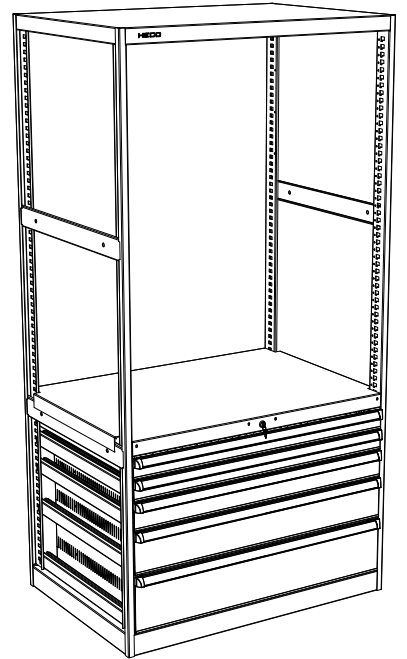

119 E 3 1 16	201 Kg			cajones/tiroirs/drawers
				2x 119 C75 1x 119 C100 1x 119 C150 1x 119 C200

SERIE 119 E 3 STANDARD

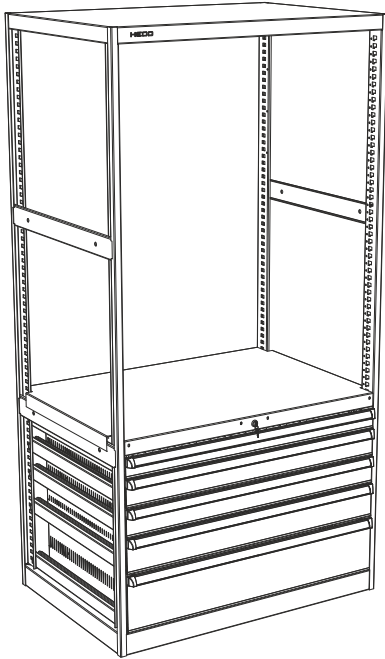

119 E 3 1 17	202 Kg			cajones/tiroirs/drawers 1x 119 C75 2x 119 C100 1x 119 C125 1x 119 C200
--------------	--------	--	--	--

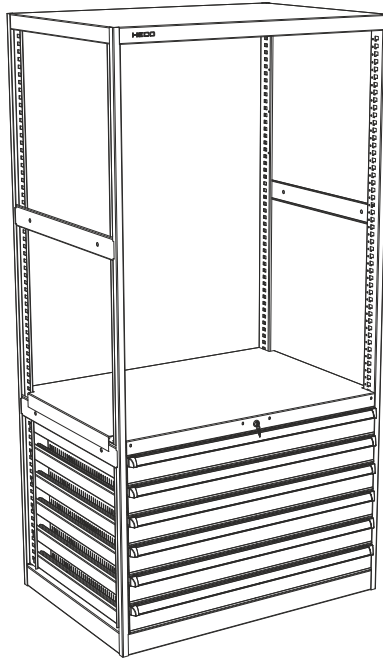

119 E 3 1 18	217 Kg			cajones/tiroirs/drawers 6x 119 C100
--------------	--------	--	--	--

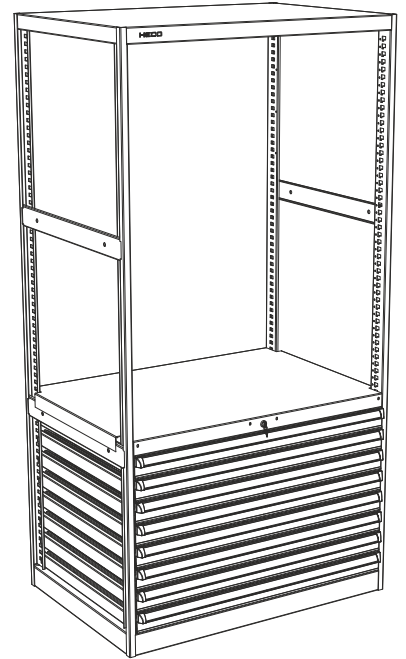

119 E 3 1 19	244 Kg			cajones/tiroirs/drawers 8x 119 C75
--------------	--------	--	--	---------------------------------------

SERIE 119 E COMPONENTES / COMPOSANTS / COMPONENTS

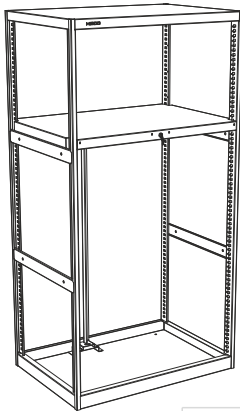

119 E 1 MC	112 Kg	LxAxH (mm) 1025x710x2000
------------	--------	-----------------------------

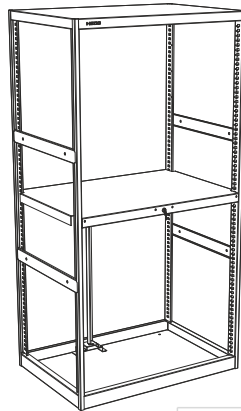

119 E 2 MC	112 Kg	LxAxH (mm) 1025x710x2000
------------	--------	-----------------------------

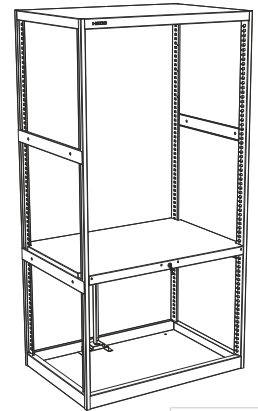

119 E 3 MC	112 Kg	LxAxH (mm) 1025x710x2000
------------	--------	-----------------------------

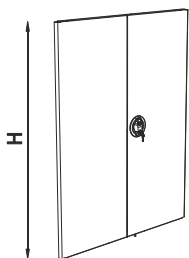

		H (mm)
119 E 1 P 1	8,4 Kg	535
119 E 2 P 2	10,7 Kg	935
119 E 3 P 3	12,5 Kg	1235
119 E P	14,3 Kg	1915

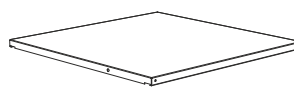

119 EG	10 Kg	descripcion/description/description estanteria graduable étagère réglable adjustable shelf
--------	-------	---

Soportes incluidos / Supports inclus / Included supports

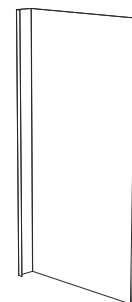

115 E L	13 Kg	LxH (mm) 730x2000
---------	-------	----------------------

lateral / latéral / lateral



SERIE 119 E P C

Armarios con cajones y estanterías (cierre con persiana).
Armoires avec tiroirs et étagères (fermeture avec rideau).
Cabinets with drawers and shelves (shutter closing).

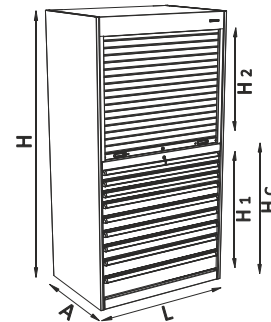

	LxAxH (mm)	H1 (mm)	H2 (mm)	Hc (mm)
119 E P C	1030x710x2000	900	785	1045

e 1 mm

	LxAxH (mm)
119 E P C	160 Kg 1030x710x2000

	descripción/description/description
119 EGP	10 Kg estantería graduable / étagère réglable / adjustable shelf

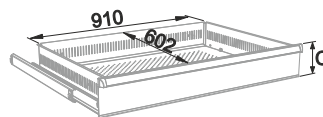

Para más información de cajones, ver PAG. 45.
Pour plus d'information de tiroirs, voir PAGE. 45.
For further information of drawers, see PAGE. 45.



Los cajones no incluyen divisiones.
Le tiroirs non inclus les séparations.
Divisions non included at drawers.



SERIE 119	C=			
	C=50	●	119 T50 C75	15,5Kg
	C=75	●	119 T50 C100	16,5Kg
	C=100	●	119 T50 C125	17,5Kg
	C=125	●	119 T50 C150	18,5Kg
	C=150	●	119 T50 C200	19Kg
	C=200	●	119 T50 C250	20Kg
	C=250	●	119 T50 C250	22,5Kg
	C=300			

e 1.5 mm

SERIE 119 E P C 2 STANDARD

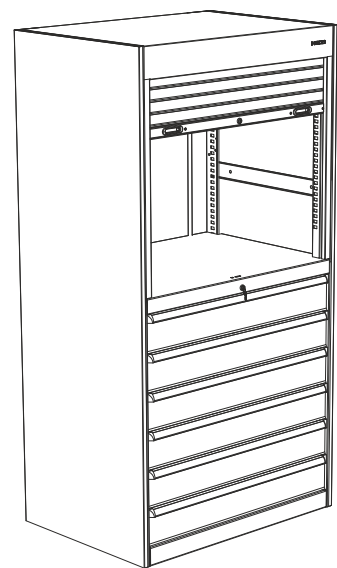
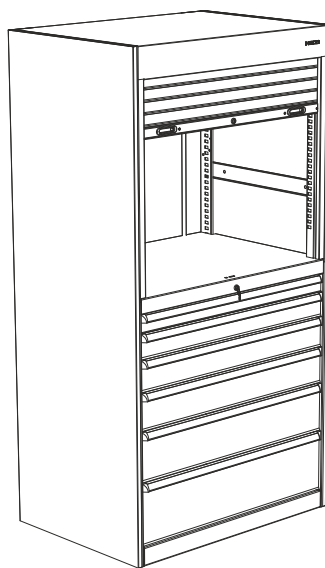
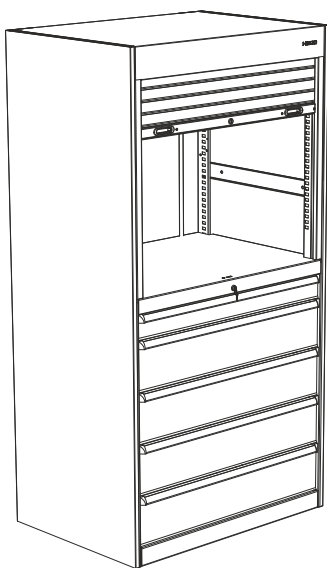

119 E P C 2 11	251 Kg	GT 100	cajones/tiroirs/drawers
			1x 119 C100 4x 119 C200

119 E P C 2 12	262 Kg	GT 100	cajones/tiroirs/drawers
			1x 119 C75 1x 119 C100 1x 119 C125 1x 119 C150 1x 119 C200 1x 119 C250

119 E P C 2 13	262 Kg	GT 100	cajones/tiroirs/drawers
			6x 119 C150

SERIE 119 E P C 2 STANDARD

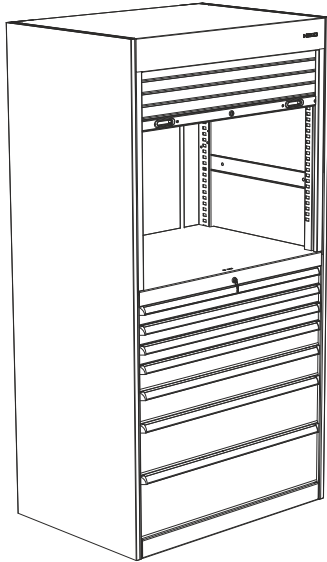

119 E P C 2 14	276 Kg	GI	UD	cajones/tiroirs/drawers
				3x 119 C75 1x 119 C100 1x 119 C125 1x 119 C200 1x 119 C250

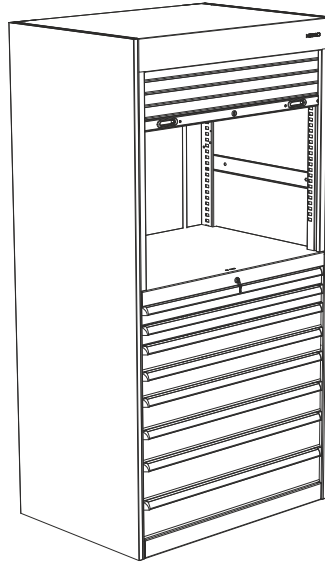

119 E P C 2 15	291 Kg	GI	UD	cajones/tiroirs/drawers
				2x 119 C75 2x 119 C100 2x 119 C125 2x 119 C150

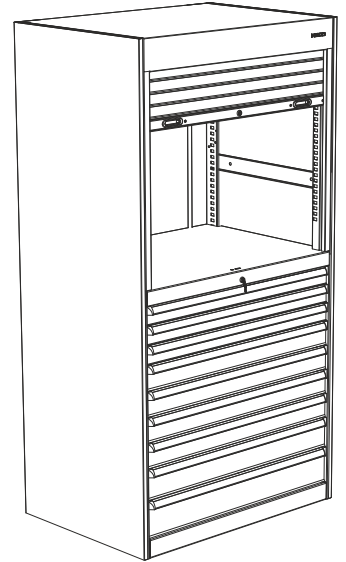

119 E P C 2 16	305Kg	GI	UD	cajones/tiroirs/drawers
				3x 119 C75 4x 119 C100 1x 119 C125 1x 119 C150

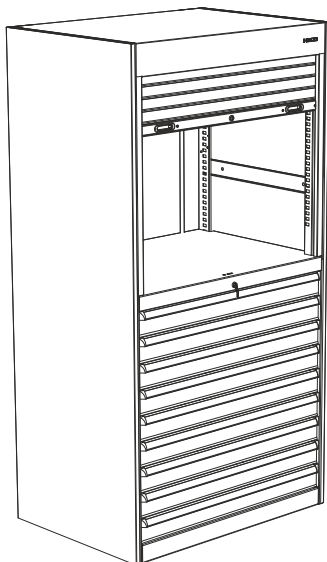

119 E P C 2 17	305,5Kg	GI	UD	cajones/tiroirs/drawers
				9x 119 C100

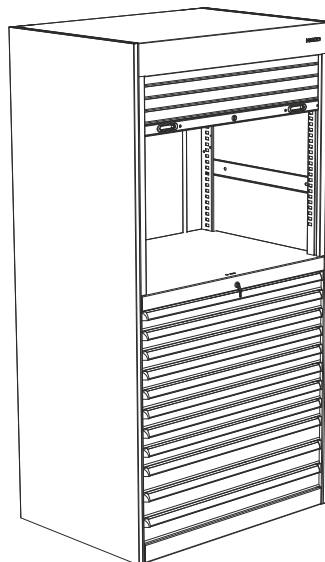

119 E P C 2 18	305,5 Kg	GI	UD	cajones/tiroirs/drawers
				8x 119 C75 3x 119 C100

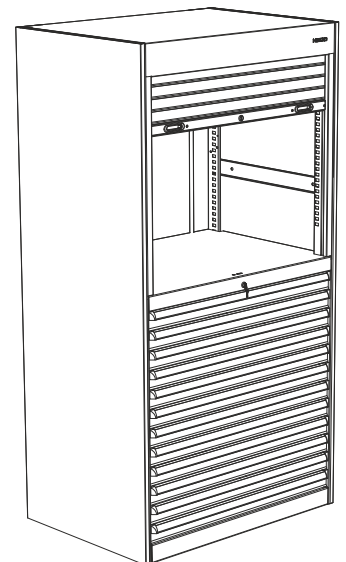

119 E P C 2 19	346 Kg	GI	UD	cajones/tiroirs/drawers
				12x 119 C75



SERIE 127 ref. 127 3 / 127 4 / 127 5 / 127 6

Armario con puertas y cajones.
Armoire avec portes et tiroirs.
Cabinets with doors and drawers.



Sistema antivuelco.
Système anti-renversement.
Roll-over protection system.

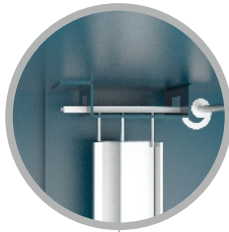

Cierre centralizado.
Verrouillage centralisé.
Central locking.

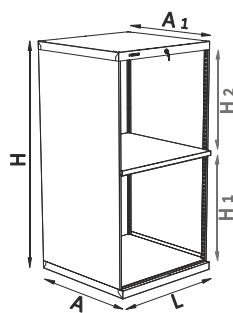
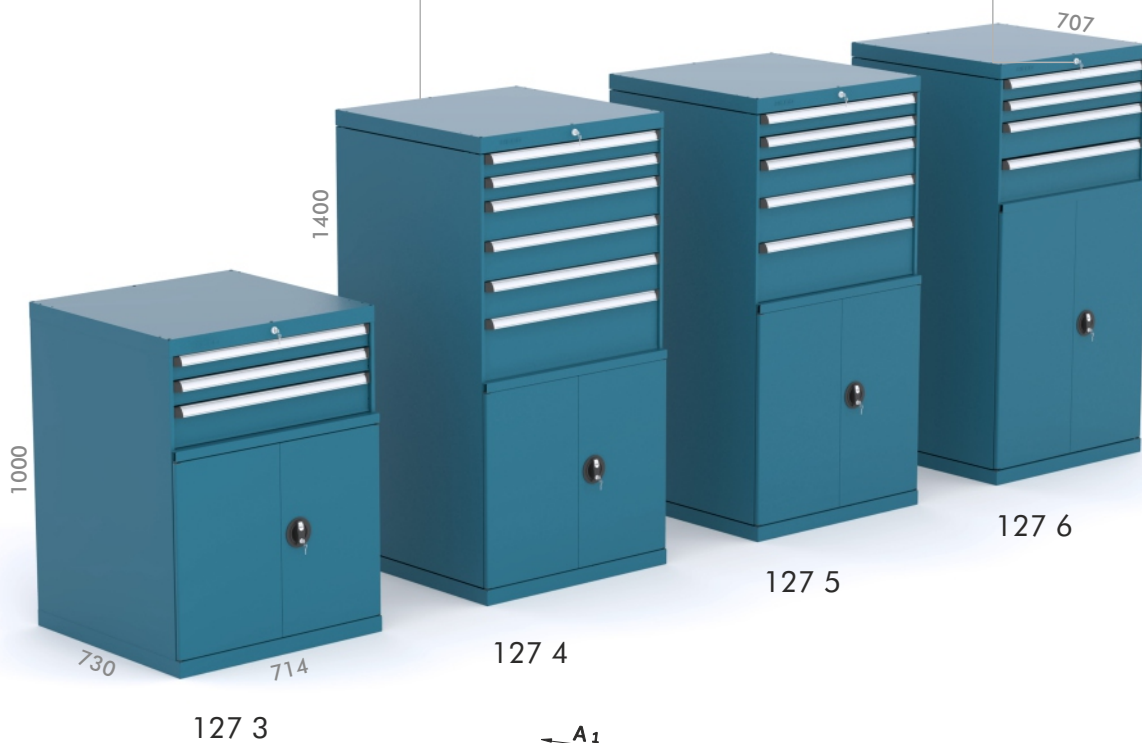
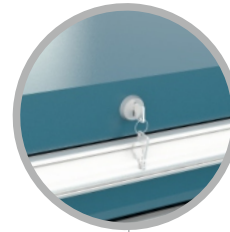

	Lx(AxA1)xH (mm)	H1 (mm)	H2 (mm)
127 3	714x(730x707)x1000	600	275
127 4	714x(730x707)x1400	900	375
127 5	714x(730x707)x1400	675	600
127 6	714x(730x707)x1400	600	675

e 1 mm

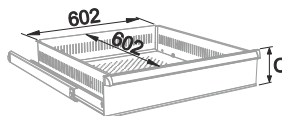

		GT	100	
			KG	
SERIE 115	C=50	●	115 T100 C50	10,5Kg
	C=75	●	115 T100 C75	11Kg
	C=100	●	115 T100 C100	12,5Kg
	C=125	●	115 T100 C125	13Kg
	C=150	●	115 T100 C150	13,5Kg
	C=200	●	115 T100 C200	14,5Kg
	C=250	●	115 T100 C250	15,5Kg
C=300				

e 1.5 mm



Para más información de cajones, ver PAG. 45.
Pour plus d'information de tiroirs, voir PAGE. 45.
For further information of drawers, see PAGE. 45.



Los cajones no incluyen divisiones.
Le tiroirs non inclus les séparations.
Divisions non included at drawers.

SERIE 127 3 STANDARD

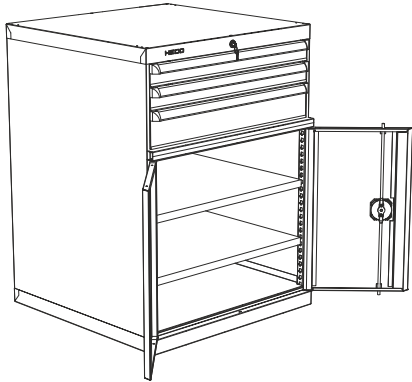

		L x A x H (mm)
127 3 1	77,5 Kg	714x730x1000
cajones/tiroirs/drawers	armario/armoire/cabinet	
2x 115 C75 1x 115 C125	2x 127 BG estantería graduable étagère réglable adjustable shelf	

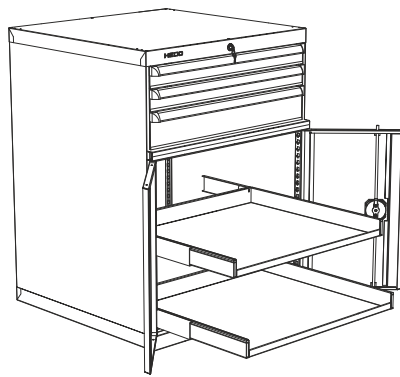

		L x A x H (mm)
127 3 2	97,5 Kg	714x730x1000
cajones/tiroirs/drawers	armario/armoire/cabinet	
2x 115 C75 1x 115 C125	2x 127 BE T100 bandeja extraíble plateau amovible tray removable	

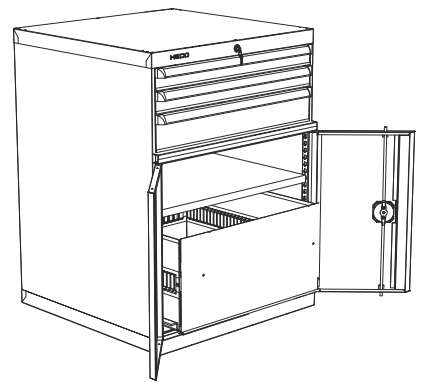

		L x A x H (mm)
127 3 3	104 Kg	714x730x1000
cajones/tiroirs/drawers	armario/armoire/cabinet	
2x 115 C75 1x 115 C125	127 BG estantería graduable étagère réglable adjustable shelf	
	127 T100 300 cajón H:300 mm tiroir H:300mm drawer H:300mm	

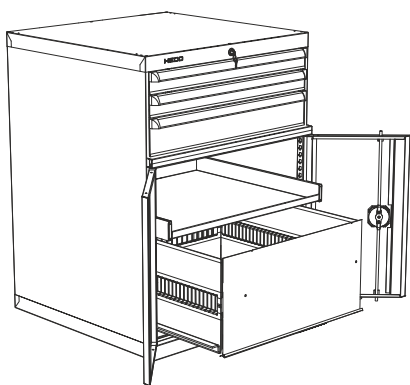

		L x A x H (mm)
127 3 4	112,5 Kg	714x730x1000
cajones/tiroirs/drawers	armario/armoire/cabinet	
2x 115 C75 1x 115 C125	127 BE T100 bandeja extraíble plateau amovible tray removable	
	127 T100 300 cajón H:300 mm tiroir H:300mm drawer H:300mm	

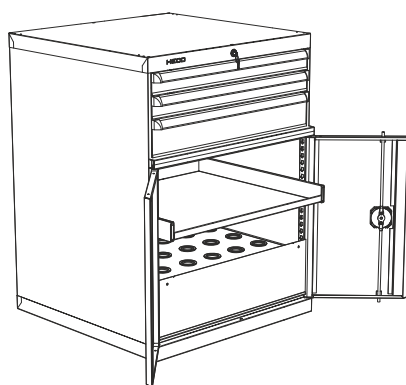

		L x A x H (mm)
127 3 5	110,5 Kg	714x730x1000
cajones/tiroirs/drawers	armario/armoire/cabinet	
2x 115 C75 1x 115 C125	127 BE T100 bandeja extraíble plateau amovible tray removable	
	127 T200 40 cajón porta conos tiroir porte-cônes tool-holder drawer	

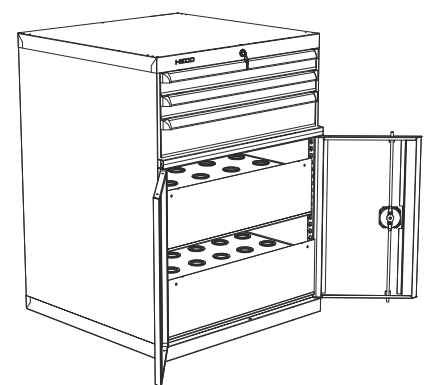

		L x A x H (mm)
127 3 6	123,5 Kg	714x730x1000
cajones/tiroirs/drawers	armario/armoire/cabinet	
2x 115 C75 1x 115 C125	127 T200 40 cajón porta conos tiroir porte-cônes tool-holder drawer	
	127 T200 50 cajón porta conos tiroir porte-cônes tool-holder drawer	



SERIE 127 4 STANDARD

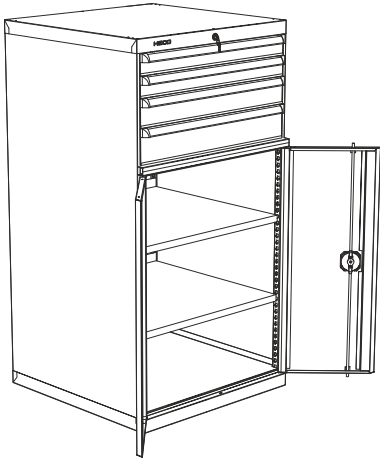

		L x A x H (mm)
127 4 1	97,5 Kg	714x730x1400
cajones/tiroirs/drawers	armario/armoire/cabinet	
2x 115 C75 1x 115 C100 1x 115 C125	2x 127 BG estantería graduable étagère réglable adjustable shelf	

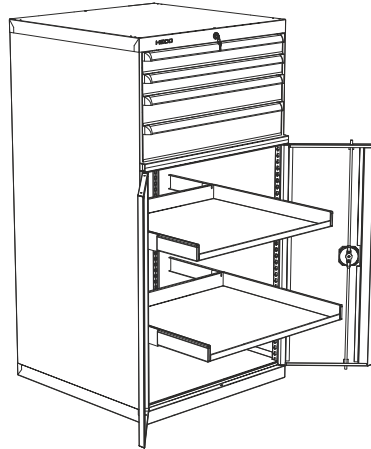

		L x A x H (mm)
127 4 2	114,5 Kg	714x730x1400
cajones/tiroirs/drawers	armario/armoire/cabinet	
2x 115 C75 1x 115 C100 1x 115 C125	2x 127 BE T100 bandeja extraíble plateau amovible tray removable	

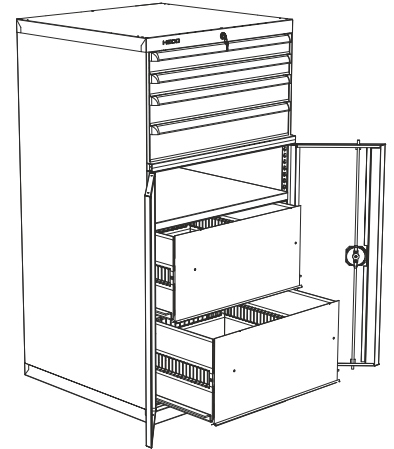

		L x A x H (mm)
127 4 3	146 Kg	714x730x1400
cajones/tiroirs/drawers	armario/armoire/cabinet	
2x 115 C75 1x 115 C100 1x 115 C125	127 BG estantería graduable étagère réglable adjustable shelf	
	2x 127 T100 300 cajón H:300 mm tiroir H:300mm drawer H:300mm 	

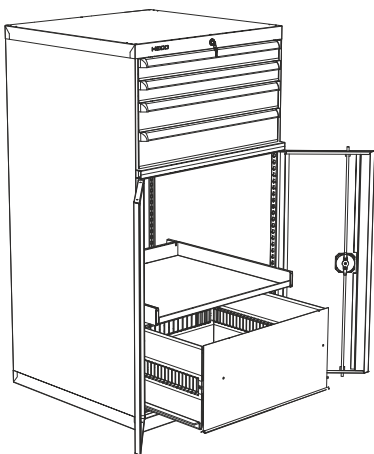

		L x A x H (mm)
127 4 4	129,5 Kg	714x730x1400
cajones/tiroirs/drawers	armario/armoire/cabinet	
2x 115 C75 1x 115 C100 1x 115 C125	127 BE T100 bandeja extraíble plateau amovible tray removable	
	127 T100 300 cajón H:300 mm tiroir H:300mm drawer H:300mm 	

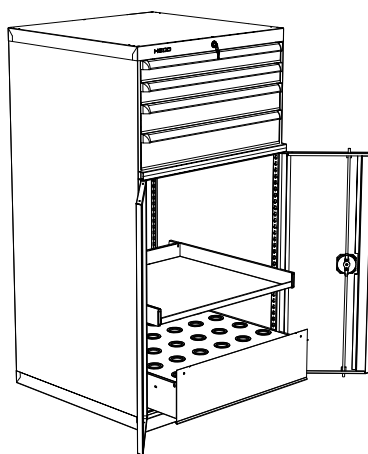

		L x A x H (mm)
127 4 5	127,5 Kg	714x730x1400
cajones/tiroirs/drawers	armario/armoire/cabinet	
2x 115 C75 1x 115 C100 1x 115 C125	127 BE T100 bandeja extraíble plateau amovible tray removable	
	127 T200 50 cajón porta conos tiroir porte-cônes tool-holder drawer 	

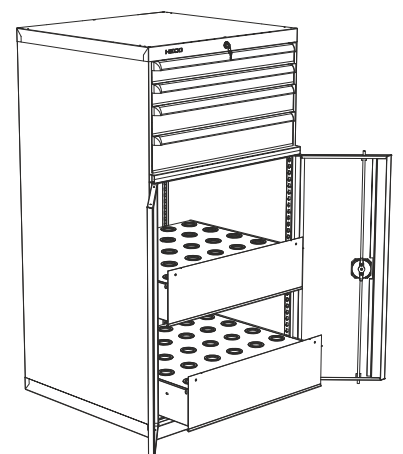

		L x A x H (mm)
127 4 6	147,5 Kg	714x730x1400
cajones/tiroirs/drawers	armario/armoire/cabinet	
2x 115 C75 1x 115 C100 1x 115 C125	127 T200 40 cajón porta conos tiroir porte-cônes tool-holder drawer	
	127 T200 50 cajón porta conos tiroir porte-cônes tool-holder drawer 	

SERIE 127 5 STANDARD

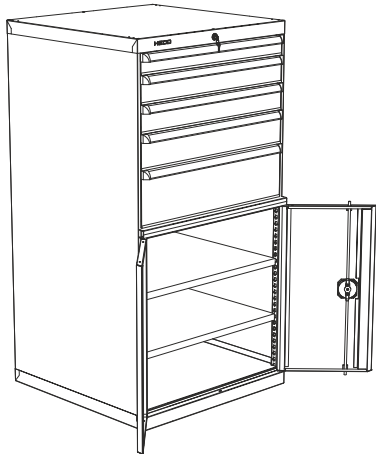

		L x A x H (mm)
127 5 1	112 Kg	714x730x1400
cajones/tiroirs/drawers	armario/armoire/cabinet	
<ul style="list-style-type: none"> 1x 115 C75 2x 115 C100 1x 115 C125 1x 115 C200 	2x 127 BG estanteria graduable étagère réglable adjustable shelf	

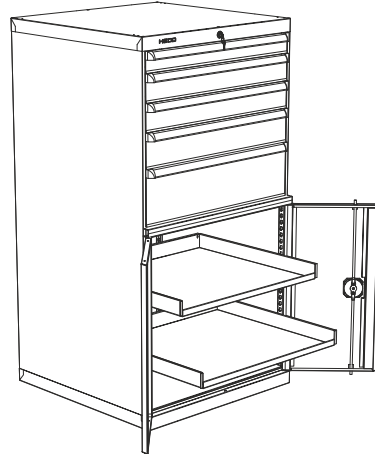

		L x A x H (mm)
127 5 2	129 Kg	714x730x1400
cajones/tiroirs/drawers	armario/armoire/cabinet	
<ul style="list-style-type: none"> 1x 115 C75 2x 115 C100 1x 115 C125 1x 115 C200 	2x 127 BE T100 bandeja extraible plateau amovible tray removable	

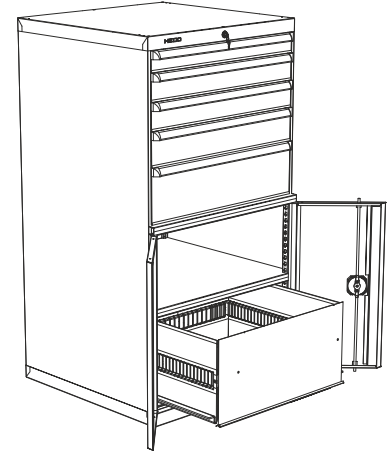

		L x A x H (mm)	
127 5 3	135,5 Kg	714x730x1400	
cajones/tiroirs/drawers		armario/armoire/cabinet	
<ul style="list-style-type: none"> 1x 115 C75 2x 115 C100 1x 115 C125 1x 115 C200 	127 BG estanteria graduable étagère réglable adjustable shelf 127 T100 300 cajón H:300 mm tiroir H:300mm drawer H:300mm		

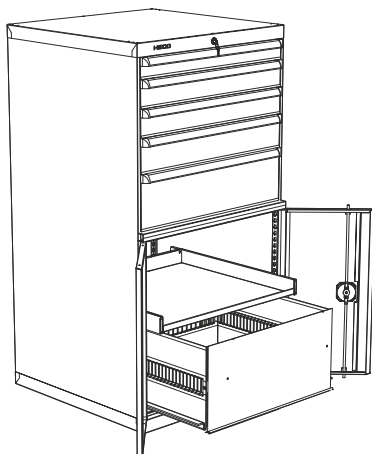

		L x A x H (mm)
127 5 4	144 Kg	714x730x1400
cajones/tiroirs/drawers	armario/armoire/cabinet	
<ul style="list-style-type: none"> 1x 115 C75 2x 115 C100 1x 115 C125 1x 115 C200 	127 BE T100 bandeja extraible plateau amovible tray removable 127 T100 300 cajón H:300 mm tiroir H:300mm drawer H:300mm	

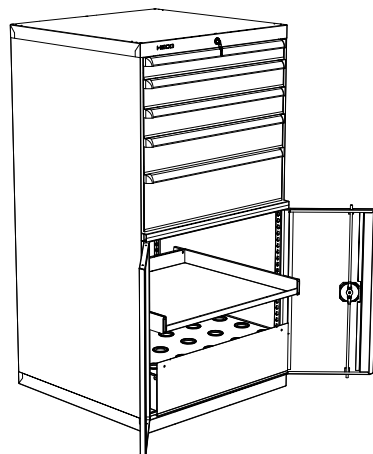

		L x A x H (mm)
127 5 5	145,5 Kg	714x730x1400
cajones/tiroirs/drawers	armario/armoire/cabinet	
<ul style="list-style-type: none"> 1x 115 C75 2x 115 C100 1x 115 C125 1x 115 C200 	127 BE T100 bandeja extraible plateau amovible tray removable 127 T200 50 cajón porta conos tiroir porte-cônes tool-holder drawer	

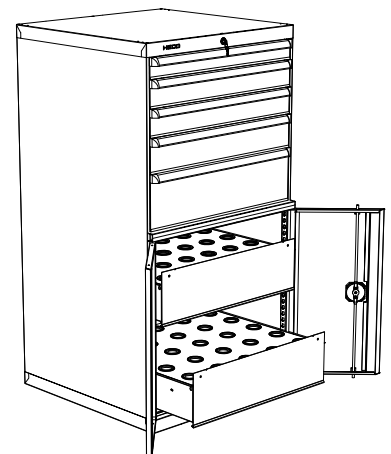

		L x A x H (mm)	
127 5 6	162 Kg	714x730x1400	
cajones/tiroirs/drawers		armario/armoire/cabinet	
<ul style="list-style-type: none"> 1x 115 C75 2x 115 C100 1x 115 C125 1x 115 C200 	127 T200 40 cajón porta conos tiroir porte-cônes tool-holder drawer 127 T200 50 cajón porta conos tiroir porte-cônes tool-holder drawer		



SERIE 127 6 STANDARD

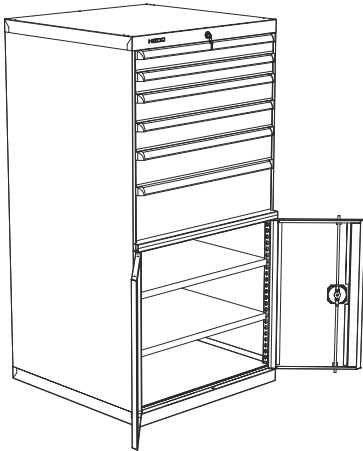

		L x A x H (mm)
127 6 1	121 Kg	714x730x1400
cajones/tiroirs/drawers	armario/armoire/cabinet	
2x 115 C75 2x 115 C100 1x 115 C125 1x 115 C200	2x 127 BG estanteria graduable étagère réglable adjustable shelf	

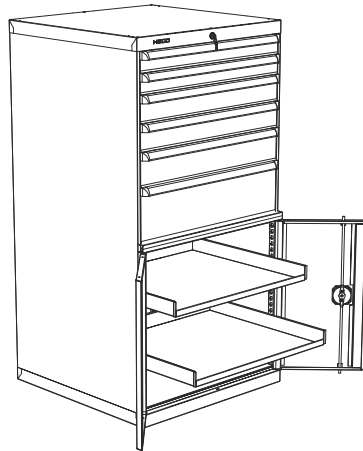

		L x A x H (mm)
127 6 2	138 Kg	714x730x1400
cajones/tiroirs/drawers	armario/armoire/cabinet	
2x 115 C75 2x 115 C100 1x 115 C125 1x 115 C200	2x 127 BE T100 bandeja extraíble plateau amovible tray removable	

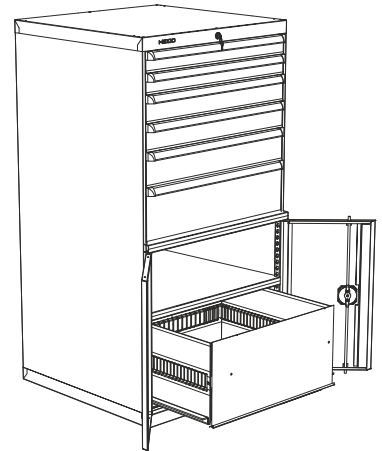

		L x A x H (mm)
127 6 3	144,5 Kg	714x730x1400
cajones/tiroirs/drawers	armario/armoire/cabinet	
2x 115 C75 2x 115 C100 1x 115 C125 1x 115 C200	127 BG estanteria graduable étagère réglable adjustable shelf 127 T100 300 cajón H:300 mm tiroir H:300mm drawer H:300mm	

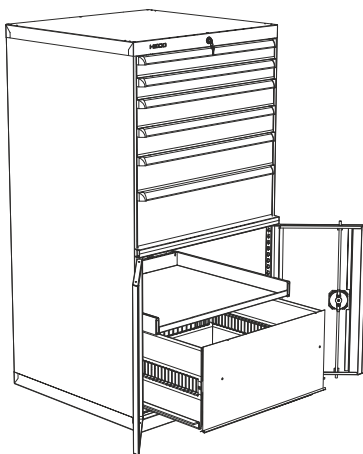

		L x A x H (mm)
127 6 4	153 Kg	714x730x1400
cajones/tiroirs/drawers	armario/armoire/cabinet	
2x 115 C75 2x 115 C100 1x 115 C125 1x 115 C200	127 BE T100 bandeja extraíble plateau amovible tray removable 127 T100 300 cajón H:300 mm tiroir H:300mm drawer H:300mm	

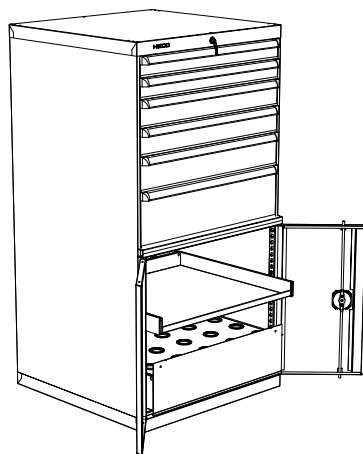

		L x A x H (mm)
127 6 5	154,5 Kg	714x730x1400
cajones/tiroirs/drawers	armario/armoire/cabinet	
2x 115 C75 2x 115 C100 1x 115 C125 1x 115 C200	127 BE T100 bandeja extraíble plateau amovible tray removable 127 T200 50 cajón porta conos tiroir porte-cônes tool-holder drawer	

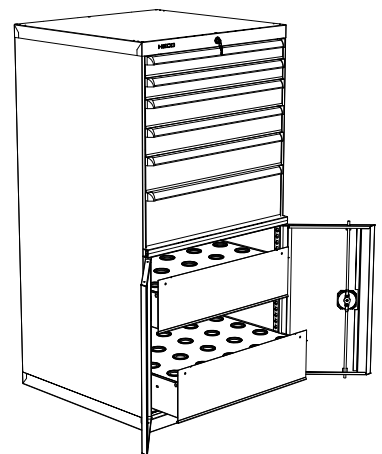

		L x A x H (mm)
127 6 6	171 Kg	714x730x1400
cajones/tiroirs/drawers	armario/armoire/cabinet	
2x 115 C75 2x 115 C100 1x 115 C125 1x 115 C200	127 T200 40 cajón porta conos tiroir porte-cônes tool-holder drawer 127 T200 50 cajón porta conos tiroir porte-cônes tool-holder drawer	

SERIE 127 STANDARD

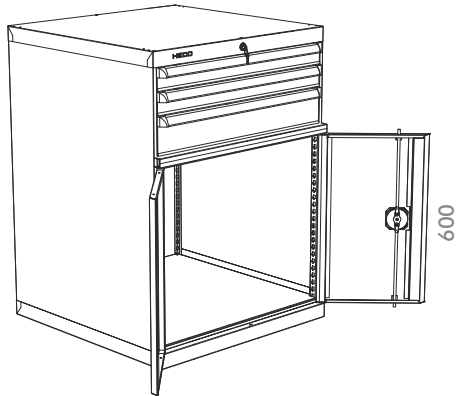

		LxAxH (mm)	
127 3	77,5 Kg	714x730x1000	cajones/tiroirs/drawers
	0,648 m ³	742x760x1150	2x 115 C75 1x 115 C125

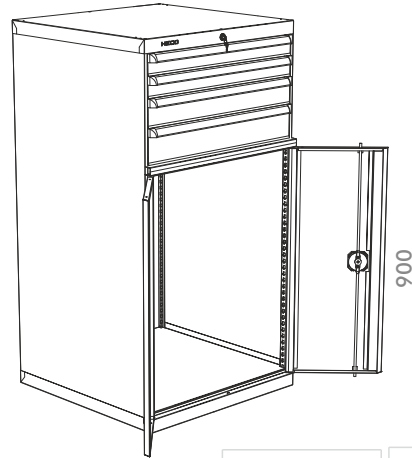

		LxAxH (mm)	
127 4	109 Kg	714x730x1400	cajones/tiroirs/drawers
	0,874 m ³	742x760x1550	2x 115 C75 1x 115 C100 1x 115 C125

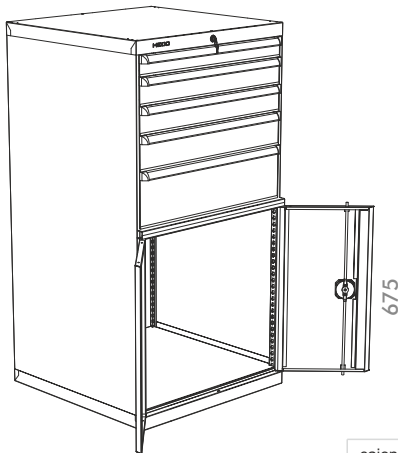

		LxAxH (mm)	
127 5	96,5 Kg	714x730x1000	cajones/tiroirs/drawers
	0,874 m ³	742x760x1550	1x 115 C75 2x 115 C100 1x 115 C125 1x 115 C200

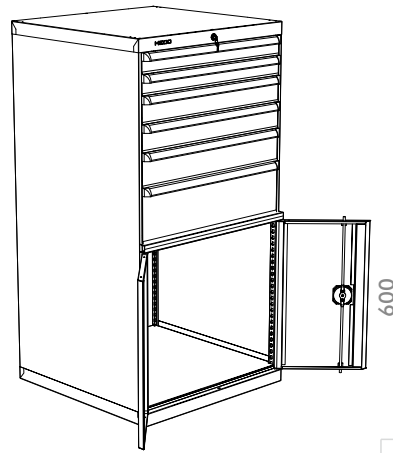

		LxAxH (mm)	
127 6	112 Kg	714x730x1400	cajones/tiroirs/drawers
	0,874 m ³	742x760x1550	2x 115 C75 2x 115 C100 1x 115 C125 1x 115 C200

INFO

ESTANTERIAS Y CAJONES / ÉTAGÈRES ET TIROIRS / SHELVES AND DRAWERS

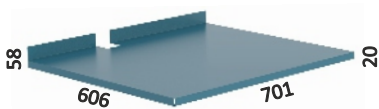

127 BG



4 Kg



127 BE T100

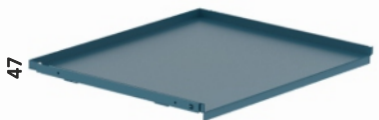

127 BE T200

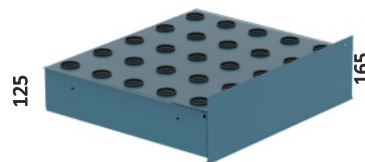

127 T200 50



25 Porta Conos ISO 50
25 Porte-Cônes ISO 50
25 Tool-Holder ISO 50

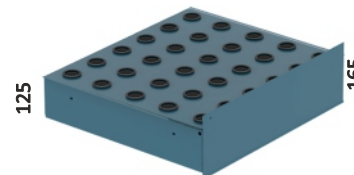

127 T200 40



25 Porta Conos ISO 40
25 Porte-Cônes ISO 40
25 Tool-Holder ISO 40

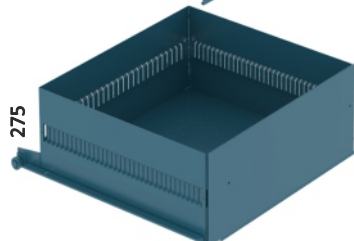

127 T100 300





MOSTRADORES
COMPTOIRS
COUNTERS



Configuraciones personalizadas según las necesidades del cliente.
Configurations personnalisées selon les besoins du client.
Customized configurations according to the needs of the client.

SERIE 115 C

Armario esquinero con y sin puertas (H:1000mm).
Armoire d'angle avec ou sans portes (H:1000 mm).
Corner cabinet with or without doors (H:1000 mm).



	LxAxH (mm)
115 C	1007x1007x1000
115 CP	810x910x1000
115 CV	1007x1007x1000

1 mm



Para armarios bajos de 707 mm de profundidad.
Pour armoires basses de 707 mm de profondeur.
For low cabinets of 707 mm depth.

SERIE 115 C

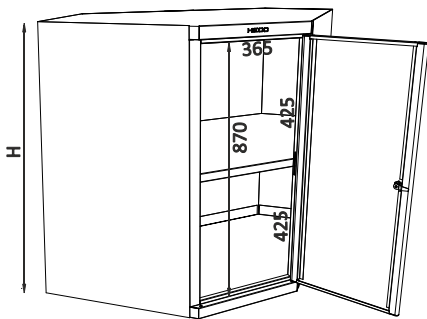

115 C



sin puertas
sans portes
without doors

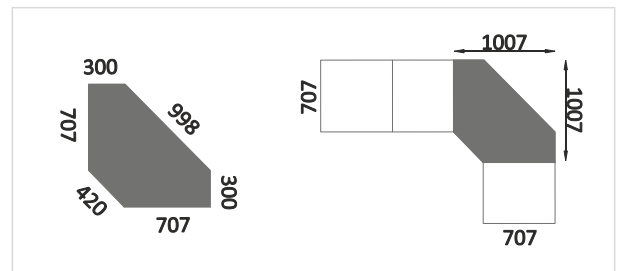

	LxAxH (mm)
115 C	67 Kg 1 m ³ 1007x1007x1000

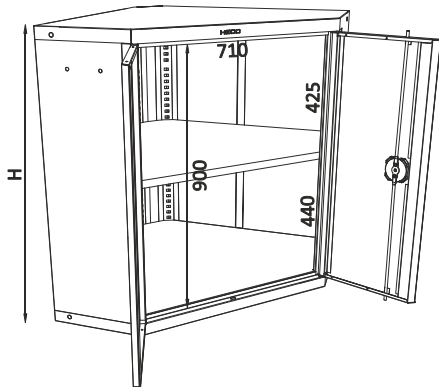

115 CP



con puertas
avec portes
with doors

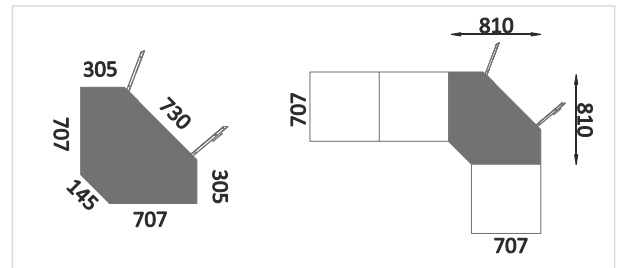

	LxAxH (mm)
115 CP	31,5 Kg 0,651 m ³ 810x810x1000

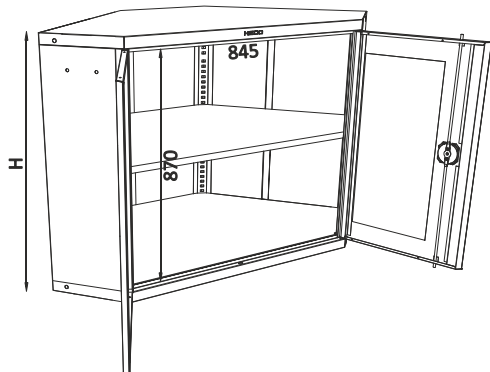

115 CV



con puertas de metacrilato
avec portes en methacrylate
with methacrylate doors

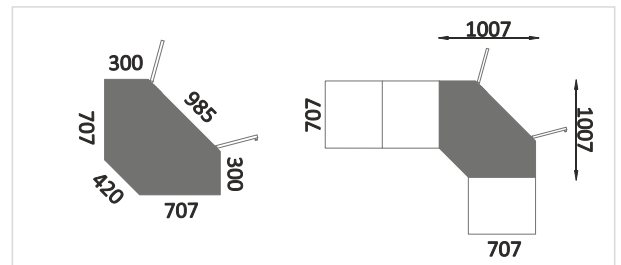

	LxAxH (mm)
115 CV	31,5 Kg 0,651 m ³ 1007x1007x1000



SERIE 122 C

Armario esquinero con y sin puertas (H:1000mm).
Armoire d'angle avec ou sans portes (H:1000 mm).
Corner cabinet with or without doors (H:1000 mm).



122 C



122 CP

	LxAxH (mm)
122 C	900x900x1000
122 CP	810x810x1000

e 1 mm



Para armarios bajos de 600 mm de profundidad.
Pour armoires basses de 600 mm de profondeur.
For low cabinets of 600 mm depth.

SERIE 122 C

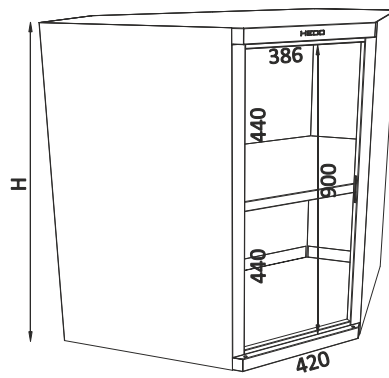
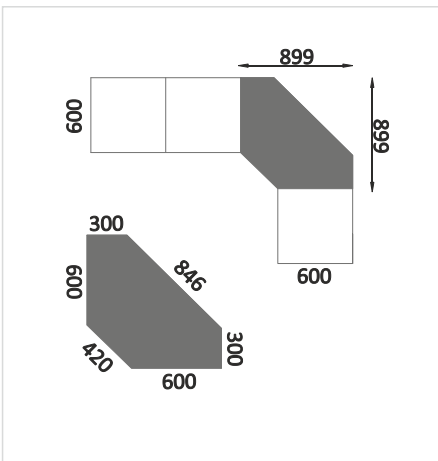

	LxAxH (mm)
122 C	67 Kg 0,804 m ³ 900x900x1000

* sin puertas / sans portes / without doors

SERIE 122 CP

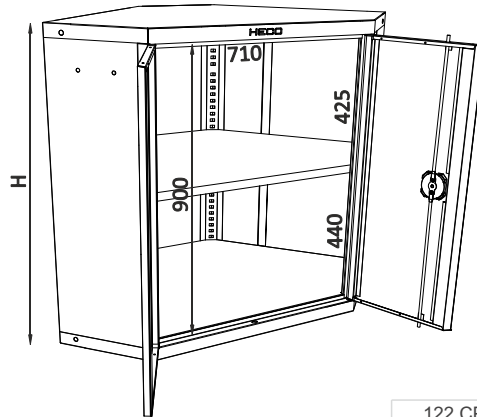
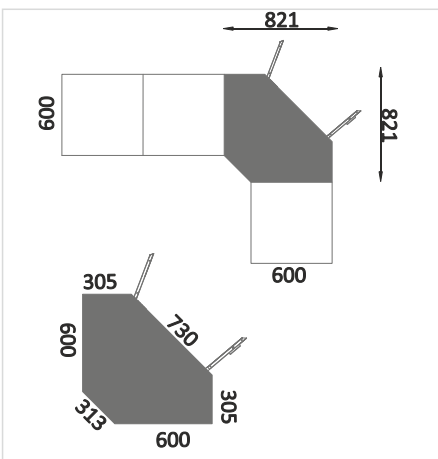

	LxAxH (mm)
122 CP	31,5 Kg 0,651 m ³ 810x810x1000

* con puertas / avec portes / with doors

MOSTRADOR: ARMARIOS CON CAJONES
COMPTOIR: ARMOIRES AVEC TIROIRS
COUNTER: CABINETS WITH DRAWERS



Para más información de configuraciones, ver PAG. 13.
Pour plus d'information de configurations voir PAGE. 13.
For further information of configurations see PAGE. 13.

MOSTRADOR: ARMARIOS CON PUERTAS
COMPTOIR: ARMOIRES AVEC PORTES
COUNTER: CABINETS WITH DOORS



Para más información de configuraciones, ver PAG. 55.
Pour plus d'information de configurations voir PAGE. 55.
For further information of configurations see PAGE. 55.

MOSTRADOR: ARMARIOS SIN PUERTAS
COMPTOIR: ARMOIRES SANS PORTES
COUNTER: CABINETS WITHOUT DOORS



Para más información de configuraciones, ver PAG. 141.
Pour plus d'information de configurations voir PAGE. 141.
For further information of configurations see PAGE. 141.



MOSTRADORES A MEDIDA
COMPTOIRS SUR MESURE
CUSTOMIZED COUNTERS

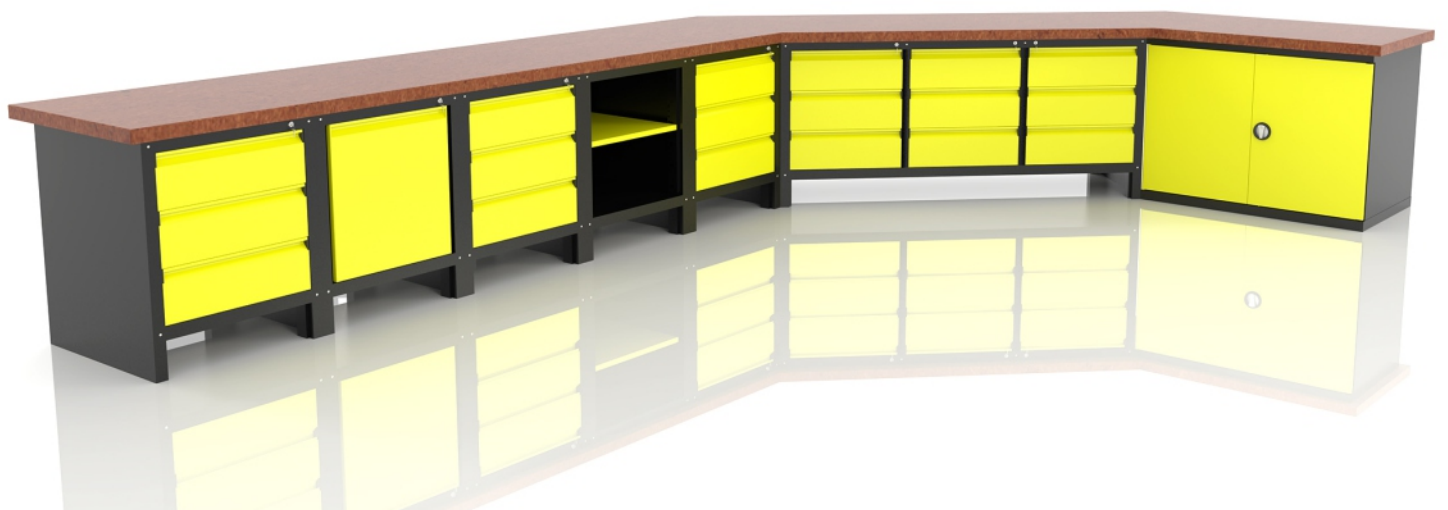
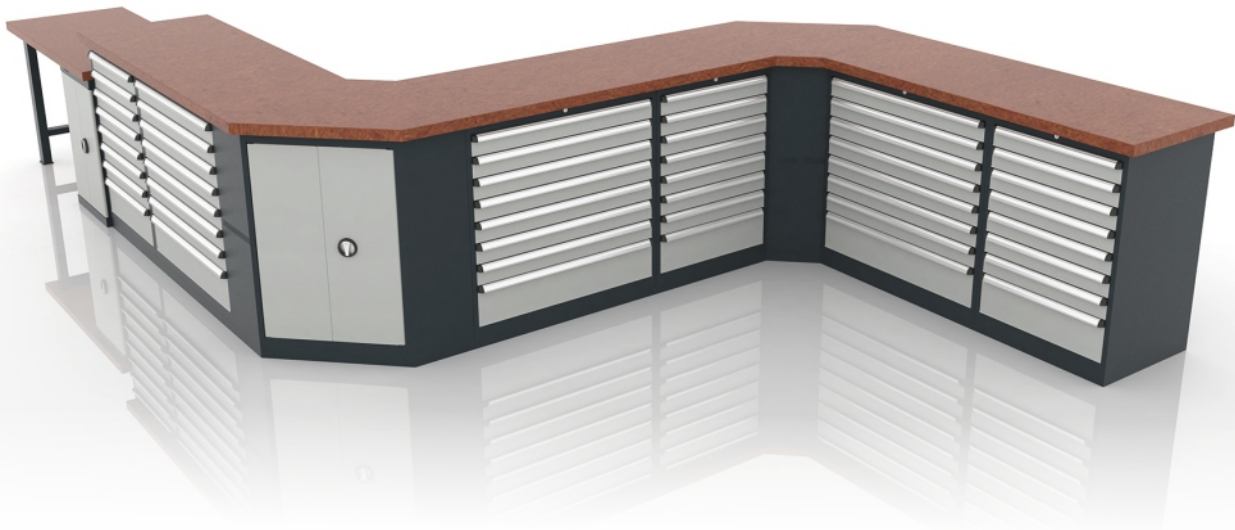

SERIE 304 BV ref. 304 BV 10 / 304 BV 15 / 304 BV 20

Bancos en acero inoxidable.
Bancs de vestiaire en acier inoxydable.
Stainless-steel bench.

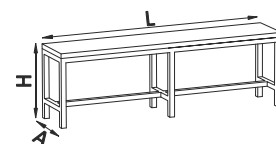
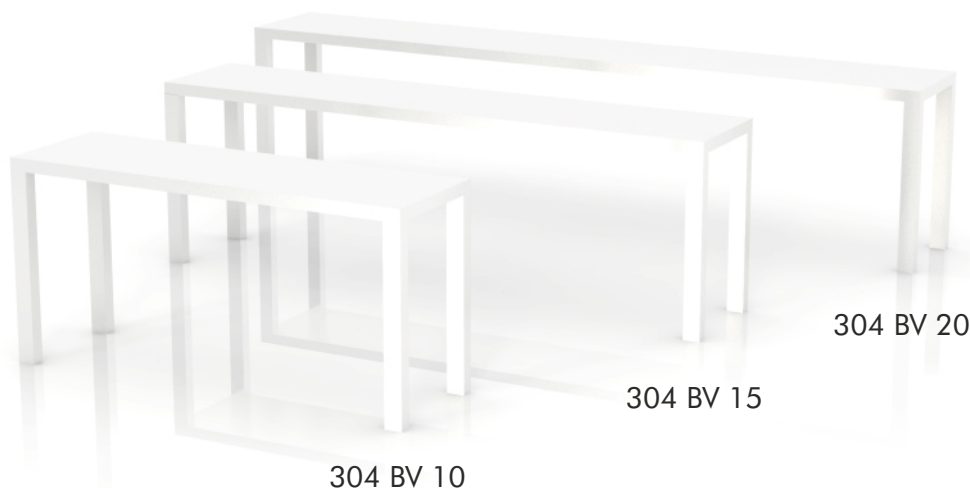

	LxAxH (mm)
304 BV 10	1000x300x450
304 BV 15	1500x300x450
304 BV 20	2000x300x450

e 1 mm



SERIE 304 BV STANDARD

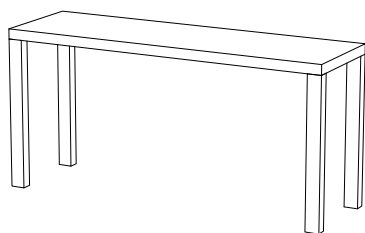

		LxAxH (mm)
304 BV 10	11 Kg	1000x300x450

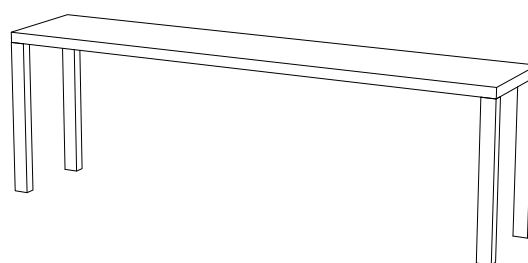

		LxAxH (mm)
304 BV 15	14,75 Kg	1500x300x450

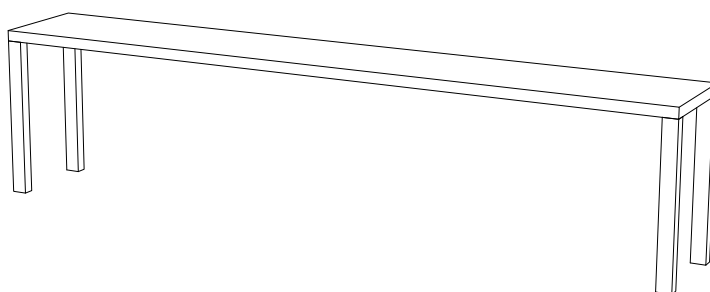

		LxAxH (mm)
304 BV 20	18,5 Kg	2000x300x450



SERIE 304 BT ref. 304 BT 15 / 304 BT 20 / 304 BT 30

Banco de trabajo en acero inoxidable.
Établi de travail en acier inoxydable.
Stainless-steel workbenches.

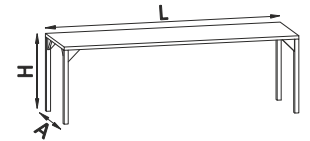

304 BT 30

304 BT 20

304 BT 15

	LxAxH (mm)
304 BT 15	1400x800x900
304 BT 20	1900x900x900
304 BT 30	2900x900x900

e 2 mm



SERIE 304 BT STANDARD

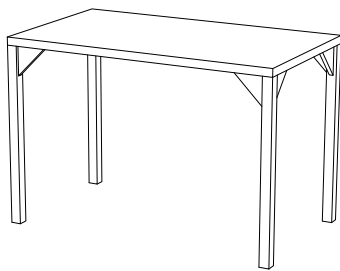

		LxAxH (mm)
304 BT 15	46 Kg	1500x800x900

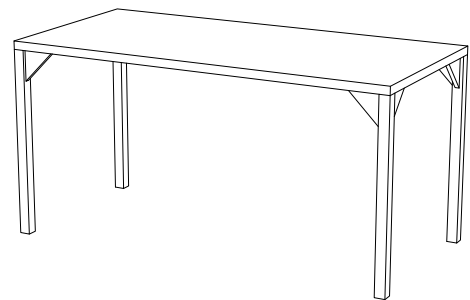

		LxAxH (mm)
304 BT 20	60 Kg	1900x900x900

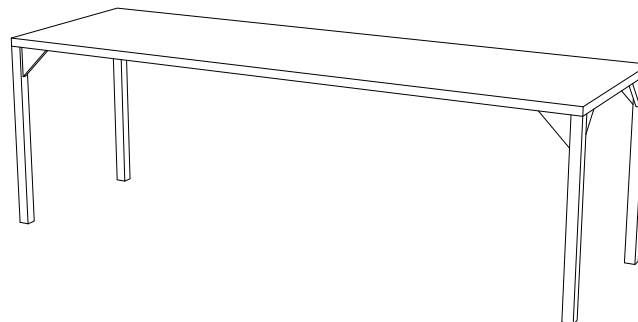

		LxAxH (mm)
304 BT 30	100 Kg	2900x900x900

SERIE 304 1

Armario vestuario en acero inoxidable.
Armoire vestiaire en acier inoxydable.
Stainless-steel lockers.

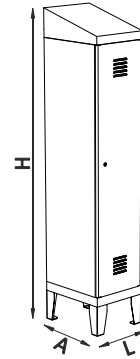

	LxAxH (mm)
304 1	310x450x2100
304 1 2	620x450x2100
304 1 3	930x450x2100
304 1 4	1240x450x2100
304 1 5	1550x450x2100

e 1 mm

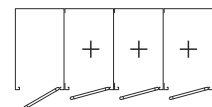

Permite agrupar hasta 5 módulos.
Permet de regrouper un maximum de 5 modules.
Up to 5 modules can be grouped together.



SERIE 304 1 STANDARD

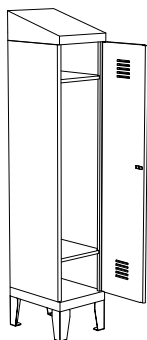
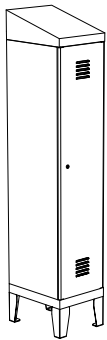

		LxAxH (mm)
304 1	30,3 Kg	310x450x2100

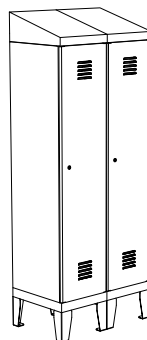

		LxAxH (mm)
304 1 2	60,6 Kg	600x450x2100

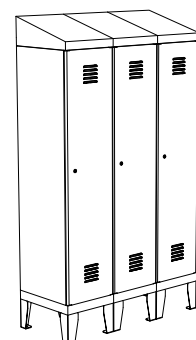

		LxAxH (mm)
304 1 3	90,9 Kg	882x450x2100



		LxAxH (mm)
304 1 4	121,2 Kg	1170x450x2100



		LxAxH (mm)
304 1 5	151,5 Kg	1452x450x2100



SERIE 304 2

Armario vestuario en acero inoxidable. Con dos puertas.
 Armoire vestiaire en acier inoxydable. Avec deux portes.
 Stainless-steel lockers. With two doors.

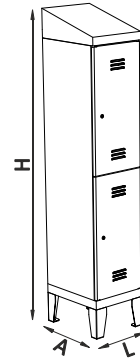

	LxAxH (mm)
304 2	310x450x2100
304 2 2	620x450x2100
304 2 3	930x450x2100
304 2 4	1240x450x2100
304 2 5	1550x450x2100

e 1 mm

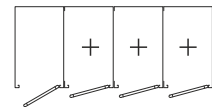

Permite agrupar hasta 5 módulos.
 Permet de regrouper un maximum de 5 modules.
 Up to 5 modules can be grouped together.

SERIE 304 2 STANDARD

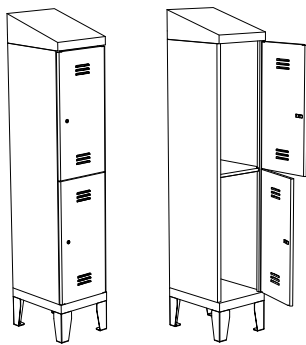

		LxAxH (mm)
304 2	30,6 Kg	310x450x2100

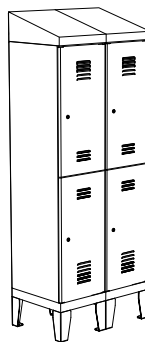

		LxAxH (mm)
304 2 2	61,2 Kg	600x450x2100



		LxAxH (mm)
304 2 3	91,8 Kg	882x450x2100



		LxAxH (mm)
304 2 4	122,4 Kg	1170x450x2100



		LxAxH (mm)
304 2 5	153 Kg	1452x450x2100

SERIE 304 3

Armario vestuario en acero inoxidable.
Armoire vestiaire en acier inoxydable.
Stainless-steel cabinet.



304 3

304 3 TI-304 4

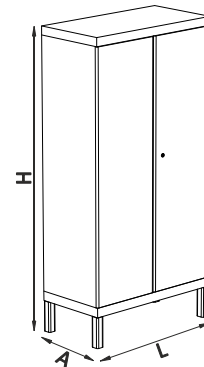

	LxAxH (mm)
304 3	980x450x2000
304 3 TI	980x450x2000
304 4	950x450x2100

1 mm



SERIE 304 3 STANDARD

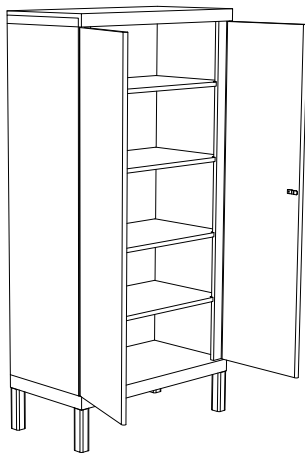

		LxAxH (mm)
304 3	80 Kg	980x450x2000

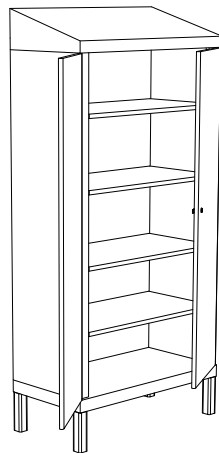

		LxAxH (mm)
304 3 TI	85 Kg	980x450x2000

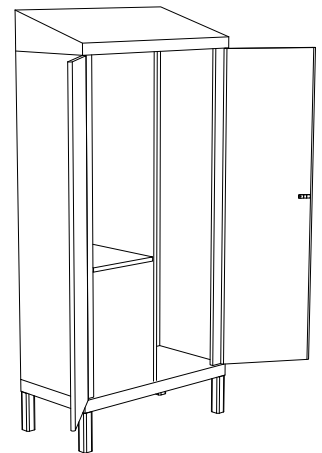

		LxAxH (mm)
304 4	65 Kg	950x450x2100



SERIE 170

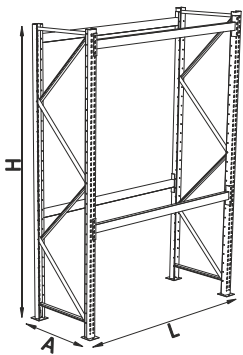

	LxAxH (mm)
170 19 08 01	1900x800x3000
170 19 10 01	1900x1000x3000
170 27 08 01	2700x800x3000
170 27 10 01	2700x1000x3000

e 1 mm



Colores estándar. RAL 5017 /
Couleurs Standard. RAL 2009



Módulos adicionales.
Modules additionnels.
Additional modules.



Resistencia: 1000 kg por estante.
Résistance: 1000 kg par étagère.
Resistance: 1000 kg pour shelf.



Las patas laterales se sirven montadas.
Les pattes latérales sont servies montées.
Side covers are delivered assembled.

SERIE 170 STANDARD

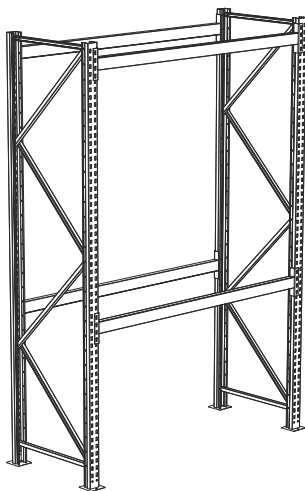

	LxAxH (mm)
170 19 08 01	105 Kg 1900x800x3000

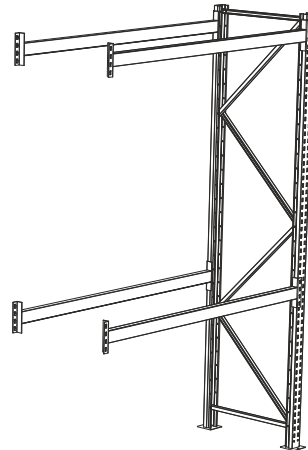

Carga total repartida por estante.
Charge totale répartie pour étagère.
Distributed total load for shelf.

1000

	LxAxH (mm)
170 19 08 02	75 Kg 1900x800x3000

Módulos adicionales. / Modules additionnels. / Additional modules.

SERIE 170 STANDARD



Carga total repartida por estante.
Charge totale répartie pour étagère.
Distributed total load for shelf.

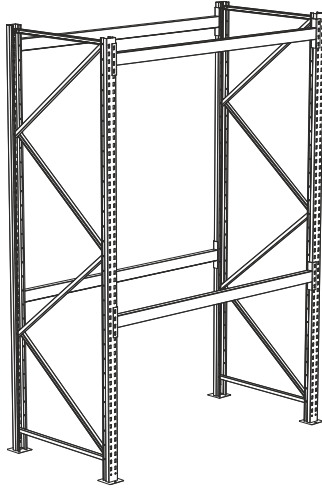

170 19 10 01	109 Kg	LxAxH (mm) 1900x1000x3000
--------------	--------	------------------------------

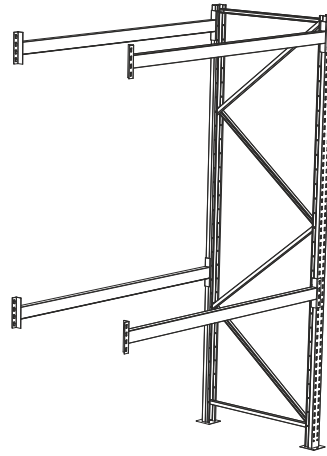

170 19 10 02	77 Kg	LxAxH (mm) 1900x1000x3000
--------------	-------	------------------------------

Módulos adicionales. / Modules additionnels. / Additional modules.

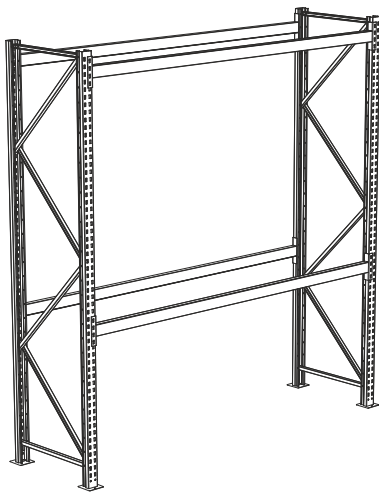

170 27 08 01	117 Kg	LxAxH (mm) 2700x800x3000
--------------	--------	-----------------------------

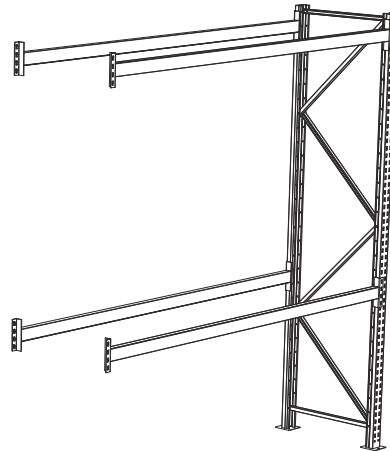

170 27 08 02	87 Kg	LxAxH (mm) 2700x800x3000
--------------	-------	-----------------------------

Módulos adicionales. / Modules additionnels. / Additional modules.

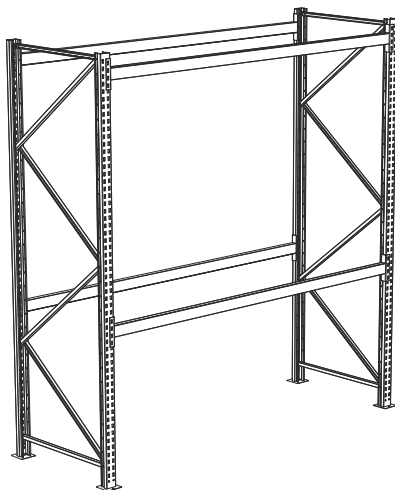

170 27 10 01	121 Kg	LxAxH (mm) 2700x1000x3000
--------------	--------	------------------------------

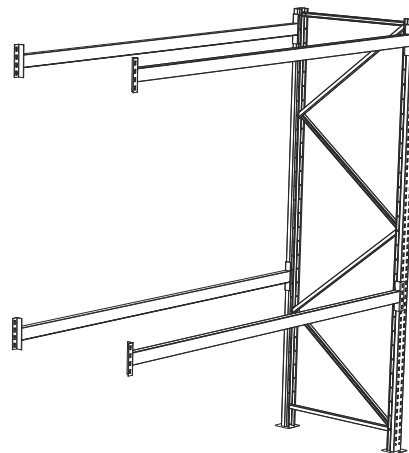

170 27 10 02	89 Kg	LxAxH (mm) 2700x1000x3000
--------------	-------	------------------------------

Módulos adicionales. / Modules additionnels. / Additional modules.



SERIE 170 COMPONENTES / COMPOSANTS / COMPONENTS

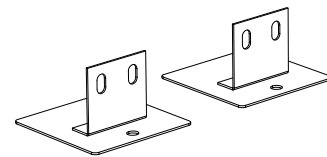
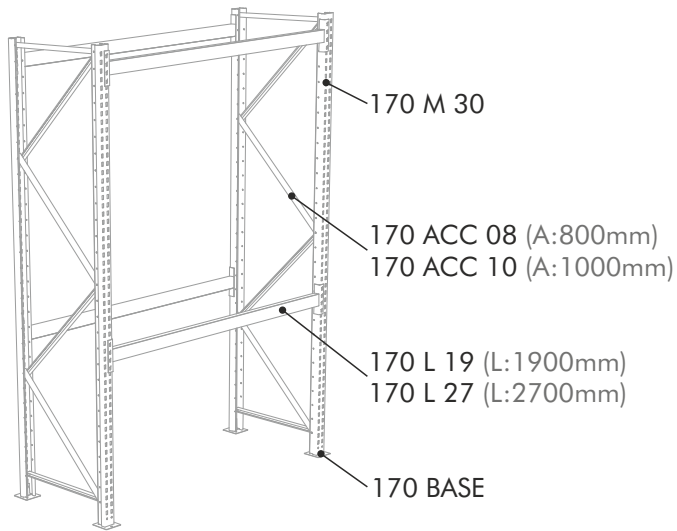

170 BASE two units
juego de dos
un jeu de deux

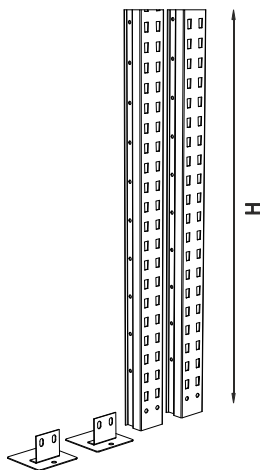

	H (mm)
170 M 30	3000

juego de dos / un jeu de deux / two units
170 BASE incluidas / inclus / included

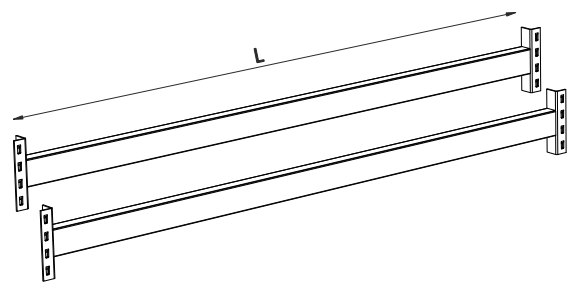

		L (mm)
170 L 19	25 Kg	1900
170 L 27	27 Kg	2700

juego de dos / un jeu de deux / two units

INCLUYE
Riostras galvanizadas;
(P800-P1000)
Separadores y tornillería.

COMPREND
Appareils dentaires galvanisés;
(P800-P1000)
Séparateurs et vis.

INCLUDES
Galvanized braces;
(P800-P1000)
Dividers and screws.

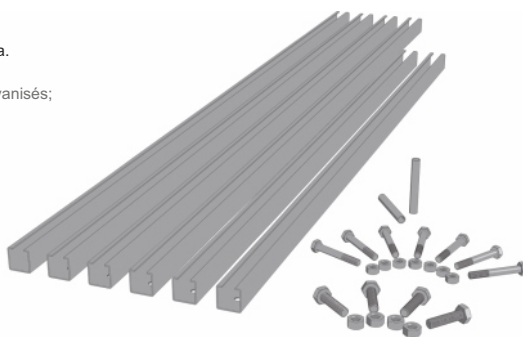

	A (mm)
170 ACC 08	8,5 Kg 800
170 ACC 10	10 Kg 1000

juego de accesorios / jeu d'accessoires / accessory set
zincado / zingué / zined

PLATAFORMAS / PLATEFORMES / PLATFORMS

TAP-09012

X: 800

TAP-09001

X: 1000 mm

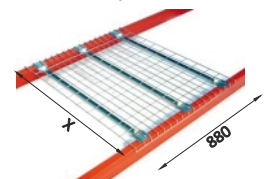

	LxAxH (mm)
TAP-09012	A:800mm 880x800
TAP-09001	A:1000mm 880x1000

SERIE 170

PROTECCIONES DE PUNTAL / PROTECTIONS DES PATTES / LEG PROTECTIONS.

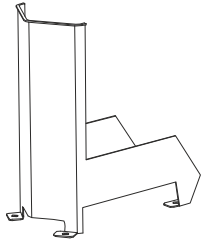

	LxAxH (mm)
TAP-10930	335x168x400

Protección "push back".
Protection "push back".
Push back protection.

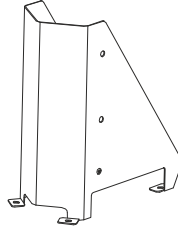

	LxAxH (mm)
TAP-10931	334x168x400

Protección de acero.
Protection d'acier.
Steel protection.

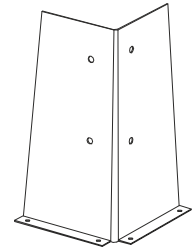

	LxAxH (mm)
TAP-10933	160x160x400

Protección de esquina.
Protection de coin.
Corner protection.

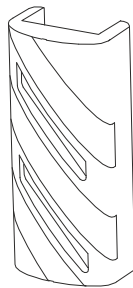

	LxAxH (mm)
TAP-35019	135x80x400

Protección magnética.
Protection magnétique.
Magnetic protection.

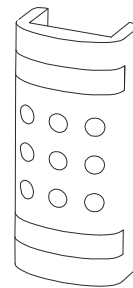

	LxAxH (mm)
TAP-35017	160x145x470

Protección con eslingas.
Protection avec élingues.
Protection with slings.

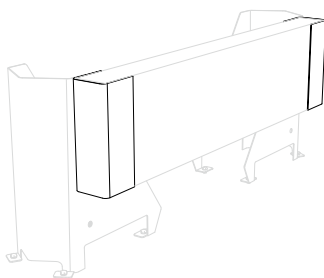

	LxAxH (mm)
TAP-10000	334x168x400

Soporte para tablero.
Support pour panneau.
Board support.

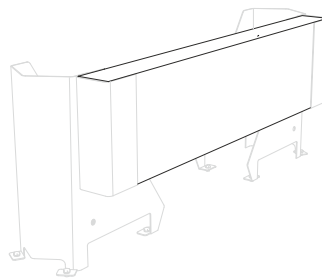

	LxAxH (mm)
TAP-35050	1150x225x75

Tablero de pino.
Panneau de pin.
Pine board.

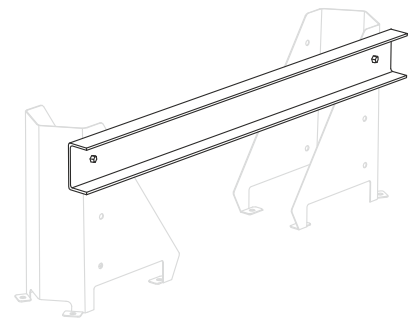

	LxAxH (mm)
TAP-10936	1000x50x100

Protección lateral.
Protection latérale.
Side protection.

